

**Tests of ATSC 8-VSB Reception Performance
of Consumer Digital Television Receivers
Available in 2005**

November 2, 2005

**Technical Research Branch
Laboratory Division
Office of Engineering and Technology
Federal Communications Commission**

**OET Report
FCC/OET TR 05-1017**

**Prepared by:
Stephen R. Martin**

FOREWORD

The author gratefully acknowledges the advice and technical support offered by the following individuals and organizations. Gary Sgrignoli and Dennis Wallace of MSW provided technical guidance at the inception of the project, and Gary Sgrignoli also provided guidance later and reviewed an early draft of this report. Mark Hryzko, Mike Gittings, Raul Casas of ATI Research, Inc. identified degraded performance of the FCC's RF capture player (which was subsequently repaired and calibrated before conducting the tests reported herein) and provided technical advice; Mark Hryzko and Kevin Murr assisted in comparative testing at ATI's laboratory using ATI's equipment as a double-check of the FCC equipment and measurement procedures for the FCC Laboratory tests reported herein. Wayne Bretl of Zenith Electronics Corp. and Rich Citta of Micronas Semiconductors, Inc. provided technical advice regarding testing with RF captures. Victor Tawil of the Association for Maximum Service Television (MSTV) and Sean Wallace of Wavetech Services, LLC provided RF captures and technical advice.

TABLE OF CONTENTS

| | |
|---|------|
| EXECUTIVE SUMMARY | iv |
| Samples..... | iv |
| Test Results..... | iv |
| CHAPTER 1 INTRODUCTION..... | 1-1 |
| Background..... | 1-1 |
| Objectives | 1-1 |
| Ability to Receive Signals | 1-2 |
| Standard for Determining Whether a Household is Unserved | 1-4 |
| Overview..... | 1-4 |
| CHAPTER 2 SCOPE AND APPROACH..... | 2-1 |
| Scope of Testing | 2-1 |
| Test Samples..... | 2-1 |
| Test Philosophy and Approach | 2-3 |
| CHAPTER 3 WHITE-NOISE THRESHOLD MEASUREMENTS (REQUIRED CARRIER-TO-NOISE RATIO) .. | 3-1 |
| Measurement Method | 3-1 |
| Format of The Bar Graph Data | 3-2 |
| Results..... | 3-2 |
| CHAPTER 4 MINIMUM INPUT SIGNAL MEASUREMENTS | 4-1 |
| Measurement Method | 4-1 |
| Results..... | 4-2 |
| CHAPTER 5 INFERRED NOISE FIGURE | 5-1 |
| Results..... | 5-2 |
| CHAPTER 6 PERFORMANCE AGAINST MULTIPATH USING FIELD CAPTURES..... | 6-1 |
| Measurement Method | 6-1 |
| Results..... | 6-2 |
| CHAPTER 7 INFERRED PERFORMANCE AGAINST REPRESENTATIVE MULTIPATH CONDITIONS | 7-1 |
| Multipath Capability Based on Year-2000 Field Tests..... | 7-1 |
| Impact of Representative Multipath on Required CNR | 7-2 |
| CHAPTER 8 SUMMARY AND CONCLUSIONS | 8-1 |
| Variation in Reception Performance..... | 8-2 |
| Price-Dependence of Reception Performance | 8-3 |
| Reception Performance Relative to OET-69..... | 8-3 |
| APPENDIX A TEST CONFIGURATIONS, ISSUES, AND PROCEDURES..... | A-1 |
| Test Configurations..... | A-1 |
| Calibration and Signal Quality Tests on Test Setups..... | A-2 |
| Test Issues..... | A-4 |
| Procedures..... | A-6 |
| Equipment..... | A-11 |
| APPENDIX B SUMMARY OF RF FIELD CAPTURES..... | B-1 |

ILLUSTRATIONS

| | |
|--|------|
| Figure 3-1. Measured White Noise Threshold of Receivers..... | 3-5 |
| Figure 4-1. Measured Minimum Signal Level at TOV on Three Channels..... | 4-5 |
| Figure 4-2. Measured Minimum Signal Level at TOV on Channel 3 (Low VHF)..... | 4-5 |
| Figure 4-3. Measured Minimum Signal Level at TOV on Channel 10 (High VHF)..... | 4-6 |
| Figure 4-4. Measured Minimum Signal Level at TOV on Channel 30 (UHF)..... | 4-6 |
| Figure 4-5. Measured Minimum Signal Level at TOV Versus Channel for Receiver G2..... | 4-7 |
| Figure 4-6. Measured Minimum Signal Level at TOV Versus Frequency for Receiver G2..... | 4-7 |
| Figure 5-1. Relationship between Minimum Signal at TOV and Required CNR..... | 5-5 |
| Figure 5-2. Noise Figure on Three Channels..... | 5-5 |
| Figure 5-3. Noise Figure on Channel 3 (Low VHF)..... | 5-6 |
| Figure 5-4. Noise Figure on Channel 10 (High VHF)..... | 5-6 |
| Figure 5-5. Noise Figure on Channel 30 (UHF)..... | 5-7 |
| Figure 5-6. Required CNR Versus Noise Figure..... | 5-7 |
| Figure 6-1. Performance Against 47 RF Captures..... | 6-6 |
| Figure 6-2. White Noise Threshold Versus Multipath Performance..... | 6-6 |
| Figure A-1. Block Diagram of Test Configuration for Required CNR and RF Capture Tests..... | A-12 |
| Figure A-2. Block Diagram of Test Configuration for Minimum Signal at TOV..... | A-12 |
| Figure A-3. Frequency Response of Each Port..... | A-13 |
| Figure A-4. Effect of Load Impedance Mismatch..... | A-13 |
| Figure A-5. Calibration Connection for Test Setup for Required CNR and RF Capture Tests..... | A-14 |
| Figure A-6. Spectra of Injected Signal and Noise at 15-dB CNR..... | A-14 |

TABLES

| | |
|---|------|
| Table 1-1. Planning Factors for DTV Reception Prediction..... | 1-4 |
| Table 2-1. DTV Receiver Samples..... | 2-2 |
| Table 3-1. Statistics of White Noise Threshold..... | 3-3 |
| Table 3-2. Product-Type/Price Variations of White Noise Threshold..... | 3-3 |
| Table 3-3. Correlation Coefficient of White Noise Threshold with Price..... | 3-4 |
| Table 4-1. Statistics of Minimum Signal Level at TOV..... | 4-2 |
| Table 4-2. Product-Type/Price Variations of Minimum Signal at TOV..... | 4-4 |
| Table 4-3. Correlation Coefficient of Minimum Signal at TOV with Price..... | 4-4 |
| Table 5-1. Statistics of Receiver Noise Figure..... | 5-2 |
| Table 5-2. Product-Type/Price Variations of Receiver Noise Figure..... | 5-3 |
| Table 5-3. Correlation Coefficient of Receiver Noise Figure with Price..... | 5-4 |
| Table 6-1. Number of Captures Successfully Played By Each Performance Tier..... | 6-3 |
| Table 8-1. Net Performance for Unimpaired Signal Relative to OET-69 Model..... | 8-4 |
| Table 8-2. Planning Factor Measurements with Unimpaired Signal..... | 8-4 |
| Table A-1. Equipment List..... | A-11 |
| Table B-1. RF Field Captures..... | B-2 |

EXECUTIVE SUMMARY

This report presents the results of laboratory tests of over-the-air digital (ATSC/8-VSB*) reception performance of 28 consumer digital television (DTV) receivers. The tests were performed to provide an empirical basis for answering questions about DTV reception capability that derive from study requirements imposed by Congress as part of the “*Satellite Home Viewer Extension and Reauthorization Act of 2004*” (SHVERA). The Act requires that the FCC conduct a six-element study. The element relevant to this report is as follows:

“consider whether ... there is a wide variation in the ability of reasonably-priced consumer digital television sets to receive over-the-air signals, such that at a given signal strength some may be able to display high-quality pictures while others cannot, whether such variation is related to the price of the television set, and whether such variation should be factored into setting a standard for determining whether a household is unserved by an adequate digital signal.”

SAMPLES

Two categories of DTV receivers were acquired for this project: digital set-top boxes (STBs) and DTVs with integrated over-the-air ATSC tuners. All receivers are standard, off-the-shelf consumer products currently on the market. STBs were included in the study because connection of an STB to an existing television represents the lowest-cost alternative for DTV reception. The measurement results in this document are reported by category (STB or integrated DTVs) and, within the DTV category, by price range (\$370 - \$1000, \$1001 - \$2000, and \$2001 - \$4200). Brands and model numbers are not reported.

TEST RESULTS

The tests performed for this report were laboratory-based measurements emulating two types of over-the-air reception conditions for DTV receivers:

- (1) Unimpaired signal (i.e., no multipath) [Chapters 3 – 5], and
- (2) Signal impaired by multipath (ghosts) [Chapter 6].

The unimpaired signal measurements can be used to quantitatively predict receiver performance under benign reception conditions—i.e., with little multipath or interference. The multipath tests, which focus primarily on particularly difficult multipath conditions, provide a basis for comparing the ability of different DTV receivers to handle difficult multipath conditions. A link between these laboratory-based measurements and earlier FCC field-test data provides a basis for anchoring the multipath results to representative, real-world reception conditions [Chapter 7].

Benign Multipath Conditions

Overall performance under benign reception conditions is indicated by minimum signal level at the threshold of visibility of errors (TOV) for each receiver. The median measured values of this parameter across all of the tested consumer DTV receivers were -82.2 dBm, -83.2 dBm, and -83.9 dBm, respectively, in the low-VHF, high-VHF, and UHF bands. These values comply, within measurement accuracy, with the -83 dBm minimum performance standard recommended by the ATSC. The corresponding medians for just the low-cost category of DTVs (-83.3 dBm, -83.4 dBm, and -84.1 dBm, respectively) were very slightly better than the medians across all of the receiver categories.

* 8-level Vestigial Side Band (8-VSB) is the over-the-air digital television (DTV) transmission format recommended by the Advanced Television Systems Committee (ATSC) and adopted by the FCC as the U.S. standard for terrestrial DTV transmission.

OET Bulletin No. 69, “*Longley-Rice Methodology for Evaluating TV Coverage and Interference*”, presents a methodology for predicting whether a household is served by a given broadcast signal. The DTV receiver model in that bulletin predicts minimum signal levels at TOV of -81.0 dBm and -84.0 dBm for VHF and UHF, respectively. While the test results presented in this report—together with data based on earlier FCC field tests—could be used to fine tune those parameters, the net effect of such changes would be small; consequently, no compelling reason is seen for such fine tuning.

Variation in minimum signal at TOV among the receivers was found to be moderately high in the low-VHF band, but small in the high-VHF and UHF bands.

In the low VHF band (as represented by TV channel 3 in these tests), the moderately high variability in performance among the samples is indicated by the 3.7-dB standard deviation among the receivers and the fact that two same-brand receivers exhibited performance significantly worse than the median—by 11 and 12 dB. (It is noted that, absent those two receivers, the standard deviation would have been a more modest 2.3 dB.)

Though the performance variation among the receivers in the low VHF band was moderately high, no statistically significant price-dependence of that variation was found. In fact, the median performance of the low-cost TVs was slightly better than that of either the mid-priced or high-priced TVs. The median performance of the tested set-top boxes was poorer than that of the integrated DTVs by 2.3 dB, though it must be noted that these were older designs (2004 and earlier models that were still on the market at the time of this report) than the integrated DTVs.

In the high-VHF and the UHF bands (represented in the tests by channels 10 and 30, respectively), the variation in reception performance among the tested receivers was small—as indicated by the 1.6-dB standard deviation in the high-VHF band and 0.9 dB in the UHF band. The variation of performance with price was judged to be both small and not statistically significant. The median performance of the high-cost TVs differed from that of the low-cost TVs by less than 0.2 dB. Set top boxes exhibited median performance 0.6 dB and 0.7 dB worse than the median of all TVs in the low-VHF and UHF bands, respectively.

Most of the variation in reception performance among the tested receivers was due to differences in *effective* noise figure rather than in the carrier-to-noise ratio (CNR) required for successful demodulation. The noise figure variations were larger than the required-CNR variations by factors ranging from 4, in the UHF band, to 16, in the low-VHF band.

Difficult Multipath Conditions

The tested receivers fall into two distinct tiers of multipath-handling capability—the upper tier representing a significant performance improvement associated with at least two companies’ newest generation of demodulator chips. While the difference in ability to handle difficult multipath conditions between the two tiers is large, linkage of the current results with earlier field test results (Chapter 7) suggests that the observed performance differences are of no consequence in the vast majority of reception locations, if an outdoor, mast-mounted antenna is used. When an indoor antenna is used, the linkage suggests that the observed performance differences would be significant in many, but probably not most, locations.

Given that both tiers of performance appeared in all three price ranges of DTVs, there appears to be no price dependence of multipath performance; however, there was a complete absence of upper-tier performers among the tested set-top boxes. This absence is attributed to the older designs of the set-top box products—all of which were introduced in the year 2004 or earlier. Among the tested DTV receivers, none that were introduced before March 2005 were found to exhibit upper-tier performance, whereas 48 percent of those introduced in or after that month performed at the upper tier level.

CHAPTER 1 INTRODUCTION

BACKGROUND

This report presents the results of laboratory tests of terrestrial over-the-air digital (ATSC/8-VSB*) reception performance of 28 consumer digital television (DTV) receivers. Though the tests involve terrestrial reception performance, the tests were performed to provide an empirical basis for answering questions about DTV reception capability that derive from study requirements imposed by Congress as part of the “*Satellite Home Viewer Extension and Reauthorization Act of 2004*” (SHVERA).

SHVERA, passed by Congress in December 2004, extends and amends the “*Satellite Home Viewer Act of 1994*”. The Act allows satellite communications providers to provide broadcast programming to satellite subscribers that are unserved by local—over-the-air—broadcast stations.

Section 204 of SHVERA requires that the Commission conduct an inquiry regarding “whether, for purposes of identifying if a household is unserved by an adequate digital signal under section 119(d)(10) of title 17, United States Code, the digital signal strength standard in section 73.622(e)(1) of title 47, Code of Federal Regulations, or the testing procedures in section 73.686(d) of title 47, Code of Federal Regulations, such statutes or regulations should be revised to take into account the types of antennas that are available to consumers.”

The act specifies six areas of inquiry. The relevant area for this report is the one that relates to characteristics of consumer digital television receivers. It states that the inquiry should

“consider whether ... there is a wide variation in the ability of reasonably-priced consumer digital television sets to receive over-the-air signals, such that at a given signal strength some may be able to display high-quality pictures while others cannot, whether such variation is related to the price of the television set, and whether such variation should be factored into setting a standard for determining whether a household is unserved by an adequate digital signal.”

The Act requires that the results and recommendations from this inquiry be reported to the Committee on Energy and Commerce of the House of Representatives and the Committee on Commerce, Science, and Transportation of the Senate.

OBJECTIVES

This report presents the results of a measurement program that was undertaken by the Technical Research Branch of the FCC Laboratory in order to address those portions of the SHVERA-required inquiry that involve characteristics of consumer digital television receivers. Accordingly, the objectives are to provide an empirical basis for answering three questions.

* 8-level Vestigial Side Band (8-VSB) is the over-the-air digital television (DTV) transmission method recommended by the Advanced Television Systems Committee (ATSC) and adopted by the FCC as the U.S. standard for terrestrial DTV transmission.

- (1) Is there a wide variation in the ability of reasonably-priced consumer digital television sets to receive over-the-air signals, such that at a given signal strength some may be able to display high-quality pictures while others cannot?
- (2) Is such variation related to the price of the television set?
- (3) Should such variation be factored into setting a standard for determining whether a household is unserved by an adequate digital signal.

ABILITY TO RECEIVE SIGNALS

The ability of a television receiver to receive over-the-air signals and display a high quality picture is influenced by the level and quality of the television signal reaching its antenna input terminal from the antenna download, the amount of noise or interference reaching the input terminal, and the properties of the television receiver—including the amount of noise created by the input circuitry of the television receiver.

Threshold

When a television receives a signal from an analog TV station using the NTSC transmission system that has been employed in the U.S. for decades, the TV exhibits a noisy picture at low signal levels. The noise is frequently termed “snow”. If the signal level increases, the amount of snow in the picture decreases very gradually. If signal level is increased until it exceeds the internally generated noise of the television’s input circuits by 34 dB (carrier-to-noise ratio = 34 dB), the picture level improves to the point that typical viewers consider the noise to be “slightly annoying”.^{*} The noise remains perceptible but is not considered annoying at a 40-43 dB carrier-to-noise ratio,[†] and ceases to be visible at all when the carrier-to-noise ratio (CNR) is 51 dB.[‡]

When a digital television receives a signal from a digital television station using the ATSC transmission system adopted by the FCC for terrestrial DTV broadcasts in the U.S., the transition from no picture to a virtually perfect picture occurs over a much narrower range of signal levels. Once a threshold signal level is reached, the TV picture is virtually perfect—limited only by the quality of the source material and the characteristics of the television display (for example, the picture tube and associated image forming circuits and software). This threshold corresponds to a carrier-to-noise ratio of only about 15 dB. If the signal is reduced below this threshold value, visible errors begin to occur in the picture—becoming more frequent with further reductions in signal level, until the picture becomes essentially unusable at a level only about 1 dB below the threshold.

Part of the task of determining the ability of a DTV receiver to receive over-the-air signals is to determine this threshold when only a DTV signal is applied to the antenna terminal (i.e., without any noise or interfering signals), as well as when both a DTV signal and source of electronic noise are applied simultaneously to the antenna terminal. The resulting measured parameters are the minimum signal at the threshold of visibility of errors (TOV) and the white noise threshold—also known as the required carrier-to-noise ratio (CNR).

^{*} Citta, Richard, and Sgrignoli, Gary, “ATSC Transmission System: VSB Tutorial”, Montreuz Symposium, June 12, 1997, p.8.

[†] Sgrignoli, Gary, “Interference Analysis of Co-Sited DTV and NTSC Translators”, IEEE Transactions on Broadcasting, Vol. 51, No. 1, March 2005, p.3.

[‡] Eilers, Carl, and Sgrignoli, Gary, “Digital Television Transmission Parameters-- ATSC Compliance Factors”, IEEE Transactions on Broadcasting, Vol. 45, No. 4, December 1999, p.12.

Multipath

A propagation phenomenon called multipath causes very different effects for analog versus digital television transmissions. Multipath is caused by the fact that the broadcast signal may reach the television antenna through several propagation paths that reflect off of various natural and man-made objects. A direct signal path encountering no reflections may also be present. The reflected signal paths are essentially delayed versions of the direct-path signal—with the delay being dependent on the additional distance traveled by each reflected signal.

With analog (NTSC) television, multipath causes one or more “ghost” images displaced horizontally from the main image. (The term “ghost” refers to the ghost-like appearance of the displaced image, which appears as a fainter version of the primary image.) Ghosts can significantly degrade picture quality even when the primary signal strength is quite high. In analog television, control of ghosts is usually accomplished by using a directional antenna oriented to selectively receive the stronger signal (usually the direct path signal) and to reject—at least to some extent—other paths, for which signals typically arrive from other directions.

With digital (ATSC) television, multipath does not cause ghost-like displaced images on the screen, though the term “ghost” is still used to describe multipath propagation. Instead, a weak ghost may have no effect on the picture at all. A somewhat stronger ghost may cause picture impairments such as blockiness or freeze frames. An even stronger ghost can completely prevent the television from decoding the digital data necessary to produce a picture and sound. Consequently, all ATSC television receivers contain a circuit called an equalizer, the function of which is to adaptively cancel ghosts. If the equalizer reduces the amplitudes of all but one signal path to a sufficiently low level, the picture will be displayed with no impairment at all. If the cancellation is insufficient, the TV may fail to produce a picture even when signal level is very strong.

Equalizer performance has been one of the primary areas of technological improvement as DTV receivers progress from one generation to the next. With advances in equalizer technology, significant improvements have been made in the ability to cancel larger amplitude ghosts, ghosts with larger delays relative to the main signal, and ghost signals arriving earlier than the main signal (in cases for which the direct path signal is either absent or weaker than reflected signals). Other researchers have noted a high degree of improvement in multipath-handling capability of the latest generation of equalizer technology.*

Consequently, a part of determining the ability of a DTV receiver to receive over-the-air signals is to characterize the ability of the receiver to handle various multipath conditions. For this study, that characterization was performed by feeding the antenna input terminal of the TV with signals that were recorded from television antennas at various locations in New York City and Washington, D.C.

It is also noted that, for DTV receivers that are compliant with the EIA/CEA-909 Antenna Control Interface specification, smart antenna technology can mitigate the effects of multipath, as well as certain other reception issues, through automatic optimization of various antenna parameters such as the effective pointing direction, polarization, and amplifier gain on a per-channel basis. The ATSC, in its “ATSC Recommended Practice: Receiver Performance Guidelines”, recommends that “in addition to the other guidelines contained herein for the handling of signal conditions that are experienced in the field, consideration of a receiver-controlled antenna, as enabled by CEA-909, is recommended” and notes that such a controllable antenna can “work in conjunction with a receiver’s equalizer, tuner, and demodulator to improve reception under conditions of multipath and unusually weak or strong signals.”† This interface was included in only one of the DTV receivers tested for this report. Though the smart antenna

* Laud, Tim, Aitken, Mark; Bretl, Wayne; and Kwak, K. Y., “Performance of 5th Generation 8-VSB Receivers”, IEEE Transactions on Consumer Electronics, Vol. 50, No. 4, November 2004.

† “ATSC Recommended Practice: Receiver Performance Guidelines”, ATSC Doc. A/74, Advanced Television Systems Committee, 17 June 2004, p.24.

functionality was not formally tested, we observed that it did offer a user-friendly way to optimize TV reception. Not only does it simplify the initial setup of the DTV for the consumer, but it also provides the advantage of instantaneously switching the antenna pointing direction—electronically—whenever the TV channel is changed.

STANDARD FOR DETERMINING WHETHER A HOUSEHOLD IS UNSERVED

Section 73.622(e) of the Commission’s rules, Code of Federal Regulations (CFR) 47, specifies a method for determining the service area of a DTV broadcast station based on OET Bulletin No. 69, “*Longley-Rice Methodology for Evaluating TV Coverage and Interference*”—hereafter referred to as OET-69. The bulletin defines the method for predicting field strength created at any given location by a television transmitter. It further defines television reception system “planning factors” that can be used to determine the field strength required for successful DTV reception.

The FCC’s defined reception planning factors include antenna gain, signal loss in the down-lead cable connecting the antenna to the television receiver, noise figure of the receiver, and required carrier-to-noise ratio. The latter two factors are functions of the DTV receiver and are a primary focus of the measurements conducted for this report. These parameters, as specified by OET-69, are shown in Table 1-1.

Table 1-1. Planning Factors for DTV Reception Prediction

| Planning Factor | Symbol | Low VHF | High VHF | UHF |
|--------------------------------------|----------------|----------------|-----------------|------------|
| Geometric Mean Frequency (MHz) | F | 69 | 194 | 615 |
| System noise figure (dB) | N _s | 10 | 10 | 7 |
| Required Carrier-to-Noise ratio (dB) | C/N | 15.2 (15) | 15.2 (15) | 15.2 (15) |

Note: The Final Technical Report of the FCC Advisory Committee on Advanced Television Service listed 15.19 dB as the C/N for the Grand Alliance DTV receiver.* In OET-69 this value is rounded to the nearest dB—i.e., 15 dB; however, in identifying “OET-69” planning factors and predictions for this report, we will round to the nearest tenth of a dB and use 15.2 dB. Combining this C/N value with the system noise figures and the -106.2 dBm thermal noise level specified in OET-69, yields a minimum signal power at TOV of -81.0 dBm in VHF and -84.0 dBm in UHF.

Although OET-69 was developed for defining service areas for channel-allocation purposes, the same approach could be used for initial prediction of whether a household is unserved by an adequate digital signal for SHVERA purposes. Consequently, this report will evaluate the validity of the OET-69 planning factors based on measurements of current-model consumer DTVs.

OVERVIEW

The laboratory-based measurements performed for this report emulated two types of over-the-air reception conditions for DTV receivers:

- (1) Unimpaired signal (i.e., no multipath) [Chapters 3 – 5], and
- (2) Signal impaired by multipath (ghosts) [Chapter 6]—focussing on particularly difficult multipath conditions.

The unimpaired signal measurements can be used to quantitatively predict receiver performance under benign reception conditions—i.e., with little multipath (commonly referred to as a white Gaussian channel). The multipath tests provide a basis for comparing the ability of different DTV receivers to

* Final Technical Report, FCC Advisory Committee on Advanced Television Service’s (ACATS), October 31, 1995, p.15 (Table 5.1).

handle difficult multipath conditions. Chapter 7 links the new, laboratory-based measurements to earlier FCC field-test data as a basis for anchoring the multipath results to representative, real-world reception conditions.

CHAPTER 2

SCOPE AND APPROACH

SCOPE OF TESTING

The parameters measured for this report to characterize each television receiver are as follows:

- (1) minimum signal at the threshold of visibility of errors (TOV);
- (2) the white noise threshold (defined at the TOV)—also known as the required carrier-to-noise ratio (CNR); and,
- (3) the number of ATSC-recommended field ensembles (RF captures) that can be successfully demodulated by the receiver.

The first two of these are measures of sensitivity of the receiver for an unimpaired signal. The latter characterizes the ability of the receiver to handle difficult multipath conditions.

While these measurements provide a basis for achieving the stated objectives of this report, it should be recognized that they do not fully characterize the over-the-air reception capability of a DTV receiver. The ATSC recommends that DTV receivers be evaluated on the basis of a wide variety of criteria that are not included in this report, such as multi-signal overload, tolerance to phase noise, co-channel rejection, adjacent-channel rejection, burst noise rejection, and a more complete characterization of multipath capability.*

TEST SAMPLES

Given the objectives of determining whether there is a wide variation in reception performance of reasonably-priced consumer digital television receivers and determining whether the variation is related to price of the receiver, an effort was made to select samples over a range of prices, but with emphasis on the lower end of the price range.

Two categories of DTV receivers were acquired for this project: digital set-top boxes (STBs) and DTVs with integrated over-the-air ATSC tuners. The selected receivers are standard, off-the-shelf consumer products currently on the market.

STBs were included in the study because connection of a set-top box to an existing television represents the lowest-cost alternative for DTV reception. Each STB includes a digital tuner and outputs necessary to drive high-definition television displays (through component video, DVI, or HDMI connections) and standard-resolution analog televisions (through a composite video output or an S-Video [Y-C] output). When driving a conventional analog television, high definition programming is down-converted to the resolution of the TV. Besides their use in enabling digital reception with analog TVs, set-top boxes are also useful to consumers who have high-definition, digital-ready televisions that do not include an ATSC tuner.

Selection Criteria

In selecting receivers for this study, several criteria were applied.

* “ATSC Recommended Practice: Receiver Performance Guidelines”, ATSC Doc. A/74, Advanced Television Systems Committee, 17 June 2004.

1. A total of about 30 samples was planned for the tests in order to balance the need for a large enough sample to provide a degree of statistical confidence in the results with the need to limit sample size for practical reasons.
2. Recently introduced models were selected, where possible, especially if the manufacturer expected a change in over-the-air digital reception performance with the newer model; in some cases this meant requesting a model that was not available when the tests were begun, but was delivered late in the test cycle or, in two cases, was delivered too late to include in this report.
3. An attempt was made to obtain one set-top box from most companies that manufacture one. (All set-top box models were of relatively old designs—introduced in the year 2004 or, in one case, 2003—even though they were the latest models available on the market.)
4. One DTV having an integrated ATSC tuner was selected from at or near the low-price end of each manufacturer's product line.
5. In addition, a mid or mid-to-high priced DTV having an integrated ATSC tuner was requested from many of the manufacturers.

Overview of the Samples

Table 2-1 summarizes the characteristics of the DTV receivers in the test sample. The receivers, which represent 16 brand names, are divided by product type—set-top box versus DTV with integrated ATSC tuner—and, within the DTV type, by price range. In most cases, prices were determined by selecting the median price from a FROOGLE search for each product conducted in August, 2005. Four products not found through FROOGLE were priced through WalMart in August, 2005, and one was priced through Amazon in September, 2005.

Table 2-1. DTV Receiver Samples

| Sample Type | Number of Samples | Display Size | Display Aspect Ratio | Display Technology |
|--|--------------------------|---------------------|-----------------------------|--|
| Set-Top Box (STB) | 5 | N/A | N/A | N/A |
| DTV with Integrated ATSC Digital Tuner: | | | | |
| • \$370 - \$1000 | 6 | 26" – 36" | 4:3 or 16:9 | Direct-View CRT |
| • \$1001 - \$2000 | 8 | 26" – 52" | 16:9 | Direct-View LCD, Plasma, CRT Rear Projection, DLP Rear Projection, LCD Rear Projection |
| • \$2001 - \$4200 | 9 | 32" – 62" | 16:9 | Direct-View LCD, Plasma, DLP Rear Projection, LCD Rear Projection |
| TOTAL | 28 | | | |

Notes:

--CRT = cathode ray tube (conventional picture tube)

--DLP = digital light processing

--LCD = liquid crystal display

In order to avoid revealing specific brands or models of the samples, test results presented in this document are reported by product type and price categories and by a letter and number code assigned to each product. The letter indicates product brand—with letters randomly assigned to brand names. Within each brand, a number is assigned in order of increasing price. For example, the designations A1, A2, and A3 represent three same-brand receivers listed in order of increasing price.

TEST PHILOSOPHY AND APPROACH

Laboratory Versus Field Testing

All testing was performed in the laboratory using either laboratory-generated signals or signals that had been digitally recorded from television antennas at various test sites in New York City and the Washington, DC area, and were replayed in the laboratory using equipment that allowed the signal to translated to any desired TV channel number for playback.

This test method offered two advantages over field-testing of the receivers:

- (1) the cost and time required for testing was far lower for lab-based tests than for field testing, which would have required transporting the bulky, heavy TVs and test equipment to multiple sites; (the TVs alone weighed 2200 pounds and had a combined width of 82 feet), and,
- (2) tests with signals that are generated or recreated (by playback) in the laboratory are expected to yield more consistent results than are field tests, in which received signal characteristics may vary significantly over the course of testing 28 receivers.

TV Channel Selection

For testing minimum signal at TOV, channels 3, 10, and 30 were selected to represent the low-VHF, high-VHF, and UHF bands, respectively. Selection was based on relatively central locations within the respective bands and an absence of local TV broadcasts on these channels.

Other tests, for which results were not expected to vary with channel, were performed on TV channel 30.

Operation and Connection of Samples

For receivers having multiple antenna inputs that could handle ATSC signals, only the input labeled “antenna A” or “antenna 1” was tested. For receivers having a radio frequency (RF) output associated with the selected antenna input, the output was externally terminated in 75 ohms.

Each set-top box was operated in a high definition mode and was connected to a high definition monitor by means of a component video output.

Test Configurations

All test and measurement setups maintained a 50-ohm impedance throughout, except at the signal source and the consumer TV inputs, which were each specified to be nominally 75 ohms. (An older, instrumented reference receiver included in one test had a 50-ohm input impedance.) The 75-ohm devices were matched to the rest of the test setup through impedance-matching pads, except that, for one of the test setups, an impedance transformer was used at the signal source to reduce losses. In addition to the impedance-matching pads, 50-ohm attenuator pads were used at various places throughout the test setups to reduce the effects of any impedance mismatches at places where such mismatches were considered likely or would be expected to have a significant impact.

The minimum signal at TOV is the only measured parameter for which absolute accuracy of the measurement equipment was a factor; consequently, that parameter was tested by connecting a signal

source—through appropriate pads, step attenuators, and cables—to one TV at a time. After adjusting the signal attenuation to achieve TOV on the TV, the output of the entire setup—with the exception of the final impedance-matching pad, was connected to a vector signal analyzer for measurement of the signal level. The only correction then necessary to determine the input to the TV was to subtract the attenuation of the impedance-matching pad from the measured level. That attenuation was measured separately.

For the measuring white noise threshold (required CNR), absolute measurement accuracy was less critical since the value to be determined was the ratio of a signal level to a noise level. To maintain accuracy of the ratio, both measurements were made with the vector signal analyzer on the same amplitude range. The reduced criticality of absolute measurement accuracy enabled the use of a splitter to simultaneously deliver the signal and noise to as many as eight TVs and to the vector signal analyzer for the quantitative measurements. The simultaneous connection reduced measurement time by allowing TV channel scans (required by many of the TVs when a signal was changed) to be performed simultaneously on multiple TVs and by reducing the need to repeatedly disconnect and reconnect cables.

Tests of the ability of each receiver to handle the multipath conditions represented by the ATSC-recommended field ensembles (RF captures) also did not require absolute accuracy in measuring the applied signal levels; consequently, the same splitter arrangement was used. The approach was to apply a signal level well above the minimum signal level at TOV (by about 50 dB) so that signal level was not an issue.

Details on the test methods and configurations are presented in Appendix A.

Thresholds

For both types of threshold measurements (required CNR and minimum signal at TOV), the reported value is the level measured on the maximum attenuation step (lowest signal level) that resulted in no observed errors in 60 seconds of viewing time. The threshold level at which the 60-second viewing time condition was met was nominally somewhere between that reported level and the next higher attenuation level (next lower signal level step); consequently, this approach can be expected to overestimate required signal levels by an average of half the attenuator step size of 0.1 dB. One could therefore justify subtraction of 0.05 dB from the measured signal levels. This subtraction was not performed, in part to compensate for the fact that TOV measurements are often based on longer observation times than the 60 seconds used in these tests.

CHAPTER 3

WHITE-NOISE THRESHOLD MEASUREMENTS (REQUIRED CARRIER-TO-NOISE RATIO)

White-noise threshold refers to the ratio of signal (“carrier”) power to noise power within the 6-MHz bandwidth of a television channel when both an unimpaired signal (no multipath) and broadband (“white”) Gaussian noise are simultaneously applied to the antenna terminal of a DTV receiver and the signal or noise power is adjusted to the point at which observable errors in the DTV picture just become invisible—i.e., the threshold of visibility (TOV). This is the carrier-to-noise ratio (CNR) required to produce a “clean” DTV picture. The definition assumes that the applied noise power is sufficiently higher than any noise generated internally by the DTV receiver circuitry so as to make the internally generated noise negligible.

At CNR levels below the white-noise threshold, picture quality rapidly degrades to the point that, only about one dB below the white-noise threshold, the picture is typically unwatchable or nonexistent.

At CNR levels above the white-noise threshold, the picture is essentially free of defects that are related to transmission and reception of the signal.

White noise threshold is of direct interest because it indicates the ability of a digital television to receive and process a DTV signal in the presence of high ambient noise levels—assuming that the signal is not significantly impaired by multipath or interference and that the ambient noise has characteristics similar to white Gaussian noise. In cases where the ambient environment is quiet, white noise threshold is useful in understanding the reception performance of a DTV receiver in the presence of noise that is internally generated within the input circuits of the receiver.

The results of this chapter apply only to signals that are unimpaired by multipath. In the presence of multipath, a higher CNR may be required to produce a clean picture. While the measurements performed for this report do not address such an increase, the topic is discussed in Chapter 7, based on earlier field test results.

MEASUREMENT METHOD

White-threshold of each receiver was measured by simultaneously injecting into the antenna port of the receiver both an unimpaired (e.g., no multipath) ATSC signal on channel 30 and white noise from a noise generator. A nine-way splitter feeding equal-length, well-shielded, low-loss cables allowed the same combination of signal plus noise to be applied simultaneously to as many as eight DTV receivers and a vector signal analyzer that was used for the measurements. As a consistency check, receiver D3 was included in each group of eight receivers that were tested; measurements of D3 were consistent within ± 0.1 dB.

Impedance-matching attenuator pads (50 ohms to 75 ohms, 5.8 dB power attenuation) at each TV receiver served to match the nominal 75-ohm impedance of the receiver antenna ports to the rest of the 50-ohm measurement system and, through the attenuation it provided, served to reduce the impact of any deviations from that nominal TV input impedance. At the vector signal analyzer, a 6-dB, 50-ohm attenuator served a similar function.

Because the small differences in loss between the various splitter outputs, cables, and pads can be expected to equally affect both the signal and the noise, the measured CNR is not affected by such differences.

The signal source for these tests was an RF player (Sencore RFP-910) playing the “Hawaii_ReferenceA” file supplied with the player. The file consisted of a 25-second repeating loop of motion video scenes shot at several outdoor locations. At each loop restart, most DTV receivers exhibited video errors related to re-locking to the signal; consequently, the first three seconds of each loop were not included in the observation time. (An ATSC signal generator, rather than the RF player, had been intended for these tests. Use of the generator would have avoided issues with loop restart time, but the generator was abandoned due to degraded signal quality.) The signal was amplified before splitting it. A step attenuator following the amplifier was used to adjust the signal level.

The noise source was a noise generator (Noise/Com UFX-7110) band limited to 700 MHz, well above the frequency of TV channel 30, thus leaving the spectrum flat across the bandwidth of the selected TV channel. The injected noise power was set nominally to -70 dBm within the 6-MHz bandwidth of channel 30—about 29 dB above the internally generated noise of a typical DTV receiver—by using a step attenuator with 0.1-dB steps. The noise power measurement (usually within 0.05 dB of -70 dBm) was then recorded. The actual injected noise power was computed by subtracting the effect of instrument noise, which was about 26 dB below the injected noise power.

Signal level was increased in 0.1-dB steps until the TV picture could be viewed for 60 seconds without observing a video error (excluding loop restart periods, as noted above). A measurement was then made of the combined power of both the injected signal and the injected noise, and the signal power was computed by subtracting the noise power (in linear power units); since the noise power at the threshold was typically about 15 dB below the signal, the net signal power was only about 0.1 dB below the measured total power.

Further details on the measurement procedure are contained in Appendix A.

FORMAT OF THE BAR GRAPH DATA

The measurement results are presented in bar-graph form in Figure 3-1. That format, explained here, is also used in subsequent chapters to present other results.

Each bar on the graph represents performance of one DTV receiver. The “Better”/“Worse” labels on the vertical axis indicate that, for the plotted parameter, lower values represent better performance.

Each receiver is designated by a letter and a numeral. The letters, which were assigned randomly, represent brand names. Thus, receivers A1, A2, and A3 are all of the same brand.

The receivers are grouped into categories. The first category is set-top boxes (STBs). The remaining categories are three different price ranges of DTVs. Within each group, the results are listed in order of the randomly assigned brand code letters rather than in price order. This approach was taken so that individual products could not be identified based on price.

The solid blue line represents the median result across all tested receivers. The dashed blue line represents the median result within each category. The dashed red line represents the mean result within each category. A wider dashed green line represents the value of the planning factor assigned to the measured parameter by OET-69.

RESULTS

The results of the white-noise threshold measurements are shown in Figure 3-1.

Nominal Performance and Variation Among Samples

Statistics of the white-noise threshold (required CNR) are shown in Table 3-1. The white noise threshold of the median receiver—measured across all tested receivers—is 15.3 dB. This is only 0.1 dB above (worse than) the corresponding planning factor value in OET-69. (Because the CNR was determined from the ratio of two power measurements performed on the same amplitude range of the same measuring instrument, it’s value is not affected by absolute calibration accuracy of the instrument and is therefore expected to be accurate to within 0.2 dB.*)

Table 3-1. Statistics of White Noise Threshold

| WHITE NOISE THRESHOLD | |
|---|------------------|
| Median across all receivers (dBm) | 15.3 |
| Median re OET-69 planning factors | 0.1 |
| Deviations of receivers from median (dB) | |
| --Best performing receiver (dB) | -0.4 |
| --Worst performing receiver (dB) | 0.5 |
| --89th percentile receiver (dB) | 0.3 |
| Standard deviation (dB) | 0.2 |
| Total span from best to worst receiver (dB) | 0.8 [†] |

The variations among receivers were quite small. The standard deviation of the CNR measurements across all receivers was 0.2 dB. The total span from best to worst performing receiver was 0.8 dB, with the worst measured white noise threshold being 0.5 dB above the median value.

Variation with Price and Type Category

Magnitude of Observed Variations With Product Type and Price

The observed performance variations among the product type and price categories were also small, as shown in Table 3-2. The least expensive way to receive a DTV broadcast is to purchase a digital set-top box and connect it to an existing TV. Median performance of set-top boxes was only 0.1 dB worse than the overall median. The median low-cost and mid-cost DTVs performed at the overall median, and the median high-cost DTV performance was 0.2 dB better than the overall median.

Table 3-2. Product-Type/Price Variations of White Noise Threshold

| WHITE NOISE THRESHOLD | |
|--|------|
| Median of Set-Top Boxes re Overall Median (dB) | 0.1 |
| Median of Low-Price DTVs re Overall Median (dB) | 0.0 |
| Median of Medium-Price DTVs re Overall Median (dB) | 0.0 |
| Median of High-Price DTVs re Overall Median (dB) | -0.2 |

* The vector signal analyzer specification sheet states that relative accuracy in RF vector mode on a single range is the sum of frequency response and amplitude linearity. If we ignore the frequency response term because the measurements are made over the same frequency range, we are left with the amplitude linearity term, which is specified as “<0.1 dB” for signal levels between 0 dB and -30 dB with respect to full scale—a condition that was met by both the signal and injected noise measurements. To this we add errors caused by the 0.1-dB attenuator step size.

[†] Span does not match difference between worst and best due to rounding of all numbers to nearest 0.1 dB.

Statistical Significance of Observed Variations With Product Type and Price

Apparent variations in performance of samples with price can be caused by random sampling effects even when there is no underlying performance/price dependence in the overall population; hence, some means is necessary to determine whether an apparent dependence observed in the sample is statistically significant.

In the case of measurements of the required CNR for the tested collection of DTV receivers, the observed variations with price are so small as to be inconsequential; consequently, assessing the statistical validity of those variations is hardly necessary. Nonetheless, an analysis is included here for completeness and to provide a comparative basis for more significant observed variations that are presented in subsequent chapters.

As seen in Table 3-3, the Pearson's correlation coefficient between required CNR and receiver price was computed as -8.6 percent when all receivers were included and +7.0 percent when only the DTVs (not set-top boxes) were included. A negative sign indicates that the required CNR appears to decrease (i.e., improve) with increasing receiver price, while a positive sign indicates that the required CNR increases (i.e., degrades) with increasing price. Determining whether any observed apparent trend is real or is an artifact of the small sample set used in the tests requires a statistical assessment.

Table 3-3. Correlation Coefficient of White Noise Threshold with Price

| Pearson's Correlation Coefficient of White Noise Threshold with Price | |
|--|-------|
| All Tested Receivers | -8.6% |
| DTVs Only (no Set-Top Boxes) | +7.0% |

The usual method of assessing the statistical significance of given value of the Pearson's correlation coefficient is to compare the magnitude of the observed correlation to values in a table of critical values of the Pearson's correlation coefficient. The technique is used to determine the likelihood that a correlation as high as that which was observed might occur randomly, for the selected sample, if there is no actual correlation between required CNR and receiver price in the larger population of all DTV receivers. Such a lookup table specifies values as a function of the "number of degrees of freedom", which is two less than the total number of samples—*assuming that the samples are independent*.

For the overall sample size used in this study (28 samples, 26 degrees of freedom), one can determine from such a table that the magnitude of an observed correlation coefficient must be 32 percent or higher in order to ensure that there is no more than a five percent probability that the observed correlation could result by random sampling effects from a larger population that has no such correlation. In the case of the 23 DTVs (i.e., excluding the set-top boxes), the magnitude of an observed correlation would have to be 35 percent or higher to meet the same criterion. (These are single-sided probabilities—i.e., the probability that a correlation magnitude will exceed, in a single direction, a given correlation value. For example, if the overall population has no correlation with price, there is a five percent probability that the correlation of a randomly selected sample of 28 receivers will exceed a 32 percent magnitude with a negative correlation—indicating decreasing CNR with increasing receiver price. There is also a five percent probability of exceeding that same magnitude with a positive correlation—indicating increasing CNR with increasing price.)

It should be noted that these statistical calculations are dependent upon a number of assumptions, including that the shape of the probability distribution of the measured parameter is normal (Gaussian), that the samples were randomly selected, and that the samples are independent. None of these assumptions is strictly true for the case at hand. Of particular concern is the independence assumption,

because it is quite likely that some of the receiver samples share critical subsystems. For example, a given tuner or demodulator design may be used in more than one of the receivers. The effect of such a commonality between samples would be to decrease the effective number of degrees of freedom in the computed Pearson's correlation coefficient. Such a decrease would increase the magnitude of correlation that would have to be observed to have a given confidence level in the result.

The observed correlations of -8.6 percent and +7.0 percent in the white-noise threshold measurements are so small as to provide no confidence that the small observed variations in performance with price reflect a real price-dependence in the overall population of DTV receivers currently on the market.

Effect of TV Channel

White noise threshold (required CNR) is expected to be dependent on the demodulator function of a DTV receiver. Since this function occurs after the tuner heterodynes the incoming RF signal from the frequency band of the TV channel to an intermediate frequency (IF), one would expect the white noise threshold to be essentially independent of TV channel number. Consequently, testing was performed on only one channel—channel 30.

In testing minimum signal level of the DTV receivers, as reported in the next chapter, there was a large variation in the results between channels for some TVs. In order to verify that the variation was not related to changes in white noise threshold, the white noise threshold of one DTV receiver was also tested on channel 3. The selected receiver was G2, the receiver with the largest variation in minimum signal level across the channels (a 13 dB difference between channels 3 and 30). For this receiver, the measured white noise thresholds on channels 3 and 30 were 15.6 and 15.5 dB, respectively; this difference is within measurement error.

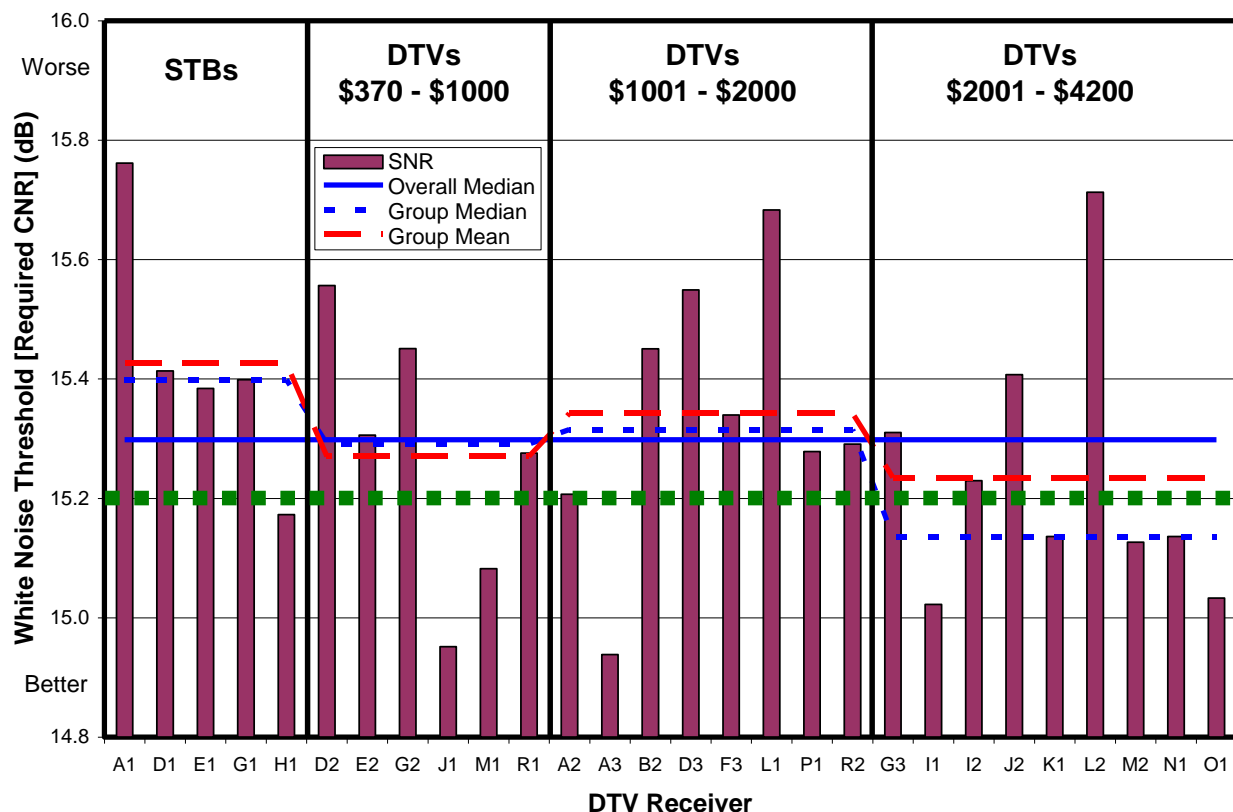

Figure 3-1. Measured White Noise Threshold of Receivers

CHAPTER 4

MINIMUM INPUT SIGNAL MEASUREMENTS

Minimum input signal at the threshold of visibility (TOV) is the signal (“carrier”) power at the antenna terminal of a DTV receiver when the signal level is adjusted to the point at which observable errors in the DTV picture just become invisible. It is a direct measure of sensitivity of a DTV receiver to weak signals in the absence of significant externally generated noise or interference—assuming that the input signal is not significantly impaired by multipath. At input levels below this threshold level, picture quality rapidly degrades to the point that, only about one dB below the white-noise threshold, the picture is typically unwatchable or nonexistent. At input levels above the threshold, the TV picture is essentially free of defects that are related to transmission and reception of the signal.

The results of this chapter apply only to signals that are unimpaired by multipath or interference. In the presence of multipath, a higher signal level may be required to produce a clean picture. While the measurements performed for this report do not address such an increase, the topic is discussed in Chapter 7, based on earlier field test results.

MEASUREMENT METHOD

Because minimum input signal at TOV is an absolute measurement rather than a ratio, the splitter was not used for these tests. The receivers were tested sequentially in groups of about eight—with receiver D3 included in each group, as a consistency check; measurements of D3 were consistent within ± 0.3 dB. The results are subject to the absolute measurement accuracy of the vector signal analyzer, which is specified as ± 1.5 dB maximum and ± 0.5 dB typical on the amplitude range that was used for the measurements;* additional errors due to adjustment for attenuation of impedance-matching pad—as described below—are expected to be negligible compared to the VSA tolerance.

The tests were performed on three TV channels—3, 10, and 30—in order to evaluate performance in the low VHF, high VHF, and UHF bands, respectively. The selection of those specific channels was based on avoiding local broadcast channels and selection of a relatively central channel within each band.

The signal source for these tests was an RF player (Sencore RFP-910) playing the “Hawaii_ReferenceA” file supplied with the player. The file consisted of a 25-second repeating loop of motion video scenes shot at several outdoor locations. At each loop restart, many DTV receivers exhibited video errors related to re-locking to the signal; consequently, the first three seconds of each loop were not included in the observation time. A step attenuator was used to adjust the signal level. The signal was applied to a single DTV receiver through a low-loss 50-ohm cable followed by a 10-dB attenuator pad and an impedance-matching attenuator pad having 5.8 dB power attenuation. The latter served to match the nominal 75-ohm impedance of the receiver antenna port to the rest of the 50-ohm measurement system. Both pads served

* As an additional check on equipment performance, measurements of injected broadband signal level and of injected broadband noise level—at levels typical of those used for white-noise threshold testing (-70 dBm for noise and -55 dBm for signal—both measured across the 6-MHz bandwidth of TV channel 30)—were performed using two instruments, the vector signal analyzer and a spectrum analyzer (Agilent E7405A). The spectrum analyzer measurements were made with the internal preamp on and the internal attenuation set to 0 dB. The spectrum analyzer overall amplitude accuracy is specified as “ $\pm(0.54$ dB + absolute frequency response)” with the absolute frequency response being specified as ± 0.5 dB over the frequency range of interest. For both signal and noise, the spectrum analyzer measurements were 0.1 dB higher than the vector signal analyzer measurements—suggesting that both instruments (which were calibrated no more than two months before the measurements reported in this chapter) were likely performing well within the specified tolerances. (Note that self calibrations were also performed on both instruments before each set of measurements.)

to minimize reflections that might be caused by any deviation of receiver input impedance from the nominal.

Signal level was increased in 0.1-dB steps until the TV picture could be viewed for 60 seconds without observing a video error (excluding loop restart periods, as noted above). The low-loss cable and 10-dB pad were then connected to a vector signal analyzer on its most sensitive amplitude range (-50 dBm) to measure the power of the applied signal. The 10-dB pad served to minimize reflections that would be caused by any deviation of the vector signal analyzer input impedance from 50 ohms. A separate measurement of instrument noise (typically about 19 dB below the measured signal level) was subtracted—in linear power units—from the measured power level to remove the very minor effects of vector signal analyzer self noise from the measurement. The attenuation of the impedance matching pad, which was connected to the TV input but not to the vector signal analyzer, was then subtracted (in dB) from the result to determine the signal level that had been applied to the DTV receiver antenna port. The presence of that pad at the TV input but not at the spectrum analyzer input served a dual purpose—matching the respective input impedances of the two devices and providing a 5.8 dB signal advantage to the vector analyzer to minimize the impact of the vector signal analyzer self noise.

Further details on the measurement procedure are contained in Appendix A.

RESULTS

The results of the minimum signal level measurements for the three tested channels are shown in Figure 4-1. Individual results for TV channels 3, 10, and 30 are shown in Figures 4-2, 4-3, and 4-4, respectively. The general format of the plots is as described in Chapter 3 in the section titled, “Format of the Bar Graph Data”, except that, in the case of Figure 4-1, there are three bars per DTV receiver—representing the three channels tested. Also, note the differences in vertical scales among the four graphs.

Nominal Performance and Variation Among Samples

Table 4-1 shows the statistical properties of the measurements of minimum signal level at TOV.

Table 4-1. Statistics of Minimum Signal Level at TOV

| MINIMUM SIGNAL LEVEL AT TOV | Chan 3 | Chan 10 | Chan 30 |
|---|---------------|----------------|----------------|
| Median across all receivers (dBm) | -82.2 | -83.2 | -83.9 |
| Median re OET-69 planning factors | -1.2 | -2.2 | 0.1 |
| Deviations of receivers from median (dB) | | | |
| --Best performing receiver (dB) | -2.5 | -1.7 | -1.4 |
| --Worst performing receiver (dB) | 12.5 | 4.3 | 2.5 |
| --89th percentile receiver (dB) | 5.1 | 3.1 | 1.3 |
| Standard deviation (dB) | 3.7 | 1.6 | 0.9 |
| Total span from worst to best receiver (dB) | 15.0 | 6.0 | 3.9 |

The median minimum signal level at TOV across all measured receivers was found to decrease slightly with increasing channel number—with channel 3 requiring a 1.7-dB higher signal than channel 30. The measured median values match—within 1 dB—the -83 dBm minimum performance standard recommended by the ATSC.*

* “ATSC Recommended Practice: Receiver Performance Guidelines”, ATSC Doc. A/74, Advanced Television Systems Committee, 17 June 2004, p.11.

The median required signal levels were slightly better—by 1.2 dB and 2.2 dB, respectively—than that predicted for the VHF-low and VHF-high bands using the OET-69 planning factors (-81.0 dBm) and closely matched the predictions for channel 30 (-84.0 dBm).^{*} On channel 3, only 21 percent of the tested receivers performed more poorly in minimum signal level than the performance modeled in OET-69 by an amount exceeding 1-dB—the approximate tolerance of the measurements.[†] On channels 10 and 30, the numbers are 11 percent and 18 percent, respectively.

The variation among receivers was large on channel 3—with a 3.7-dB standard deviation. The two receivers exhibiting poorest performance performed at levels 10.6 and 12.5 dB worse than the median. Those two receivers—both the same brand—are responsible for much of the observed variability; omitting them from the calculations reduces the standard deviation to 2.3 dB. The third worst performer was 6.7 dB above the median. 89 percent of the receivers (all but three) were within 5.1 dB of the median.

Variations were relatively small on channels 10 and 30. Standard deviation across all receivers was 1.6 dB on channel 10 and 0.9 dB on channel 30. The worst performers differed from the median by 4.3 and 2.5 dB, respectively, on channels 10 and 30, and 89 percent of the receivers (all but three) were no more than 3.1 dB above (worse than) the median on channel 10 and no more than 1.3 dB above (worse than) the median on channel 30.

Variations With TV Channel For One Sample

At least two TVs exhibited a much larger than expected variation in reception performance—as measured by minimum signal level at TOV—between the three tested TV channels. In order to further characterize this variation, the receiver exhibiting the largest variation between channels (receiver G2) was further tested to determine minimum signal at TOV for each of the 12 VHF channels and for three UHF channels. The results, shown in Figure 4-5, indicate that the receiver exhibits poor sensitivity throughout the low-VHF band (channels 2 through 6), but good sensitivity throughout the high-VHF band (channels 7 through 13) and the UHF band. On average, the high-VHF and UHF performance is 13 dB better than the low-VHF performance. The reason for this performance difference is not known.

The apparently abrupt change in sensitivity occurring between channels 6 and 7 is easier to understand if the data is plotted as a function of frequency, as in Figure 4-6. It can be seen that there is a large gap in frequency between TV channels 6 and 7, and that the increase in minimum signal at TOV that occurs in moving from the high-VHF band (channels 7-13) to the low-VHF band (channels 2-6) appears to actually begin, to a small degree, in the lower portion of the high-VHF band. (Note that the measured data is indicated by square symbols and measured points are connected by straight lines.)

Variation with Price and Type Category

Magnitude of Observed Variations With Product Type and Price

As can be seen in Table 4-2, the observed variations in minimum signal level at TOV with product type and price categories were very small for channels 10 and 30 (category medians differing from overall median by less than 1 dB) and were somewhat larger for channel 3. On channel 3, median performance of set-top boxes was 2.0 dB worse than the overall median of all receivers and the best median performance was achieved by the low-price DTV category, which slightly outperformed the medium and high-priced categories. Most of the differences in median values between categories are so small as to be

^{*} See note for Table 1-1.

[†] Absolute measurement accuracy of the vector signal analyzer on the amplitude range that was used for the measurements was as ± 1.5 dB maximum and ± 0.5 dB typical.

considered insignificant, and even the largest differences would influence reception performance only in locations where the signal margin is very small.

Table 4-2. Product-Type/Price Variations of Minimum Signal at TOV

| MINIMUM SIGNAL LEVEL AT TOV | Chan 3 | Chan 10 | Chan 30 |
|--|---------------|----------------|----------------|
| Median of Set-Top Boxes re Overall Median (dB) | 2.0 | 0.5 | 0.7 |
| Median of Low-Price DTVs re Overall Median (dB) | -1.1 | -0.2 | -0.2 |
| Median of Medium-Price DTVs re Overall Median (dB) | 0.0 | 0.5 | 0.0 |
| Median of High-Price DTVs re Overall Median (dB) | -0.7 | -0.3 | 0.0 |

Statistical Significance of Observed Variations With Product Type and Price

Table 4-3 shows the Pearson’s correlation coefficient between the minimum signal at TOV and the price of each DTV receiver. Random sampling effects can lead to apparent correlations in a given collection of DTV receivers even if the overall DTV population of receivers on the market exhibits no such correlation; consequently, a statistical assessment must be performed in order to judge whether the observed correlation reflects an actual correlation in overall population or is simply an artifact of sampling.

Table 4-3. Correlation Coefficient of Minimum Signal at TOV with Price

| Pearson’s Correlation Coefficient of Minimum Signal at TOV with Price | Chan 3 | Chan 10 | Chan 30 |
|--|---------------|----------------|----------------|
| All Tested Receivers | -14.3% | -4.9% | +3.9% |
| DTVs Only (no Set-Top Boxes) | -0.3% | +0.4% | +12.3% |

Chapter 3 explains the methods and pitfalls of such a statistical assessment. Using typical assumptions, one would conclude that an observed correlation coefficient with a magnitude of 32 percent or higher is unlikely to occur (less than five percent probability) in a sample size of 28 (the total number of receivers tested for this report) if there is no correlation in the overall population. Similarly, with a sample size of 23 (the number of DTVs—excluding set-top boxes—tested for this report), a correlation coefficient magnitude of 35 percent or higher is unlikely to occur if there is no correlation in the overall population. Thus, we would conclude that an observed correlation is statistically significant only if its magnitude exceeds the appropriate one of these thresholds.*

None of the price/performance correlations found here come even close to the threshold for statistical significance. Thus, the measurements of minimum signal at TOV show no statistically significant correlation of performance with price.

* As is explained in Chapter 3, the statistical assessment performed above is dependent upon a number of assumptions that are not strictly true for the case at hand. Arguably, the most questionable of these is the assumption that the performance of the each receiver sample is independent of the others. It is quite likely that some of the receiver samples share critical subsystems, which would violate the independence assumption. For example a given tuner or demodulator design may be used in more than one of the receivers. The effect of such a commonality between samples would be to decrease the effective number of degrees of freedom in the computed Pearson’s correlation coefficient. Such a decrease would increase the magnitude of correlation that would have to be observed to have a given confidence level in the result. Taking this effect into account would further diminish any statistical significance of the results.

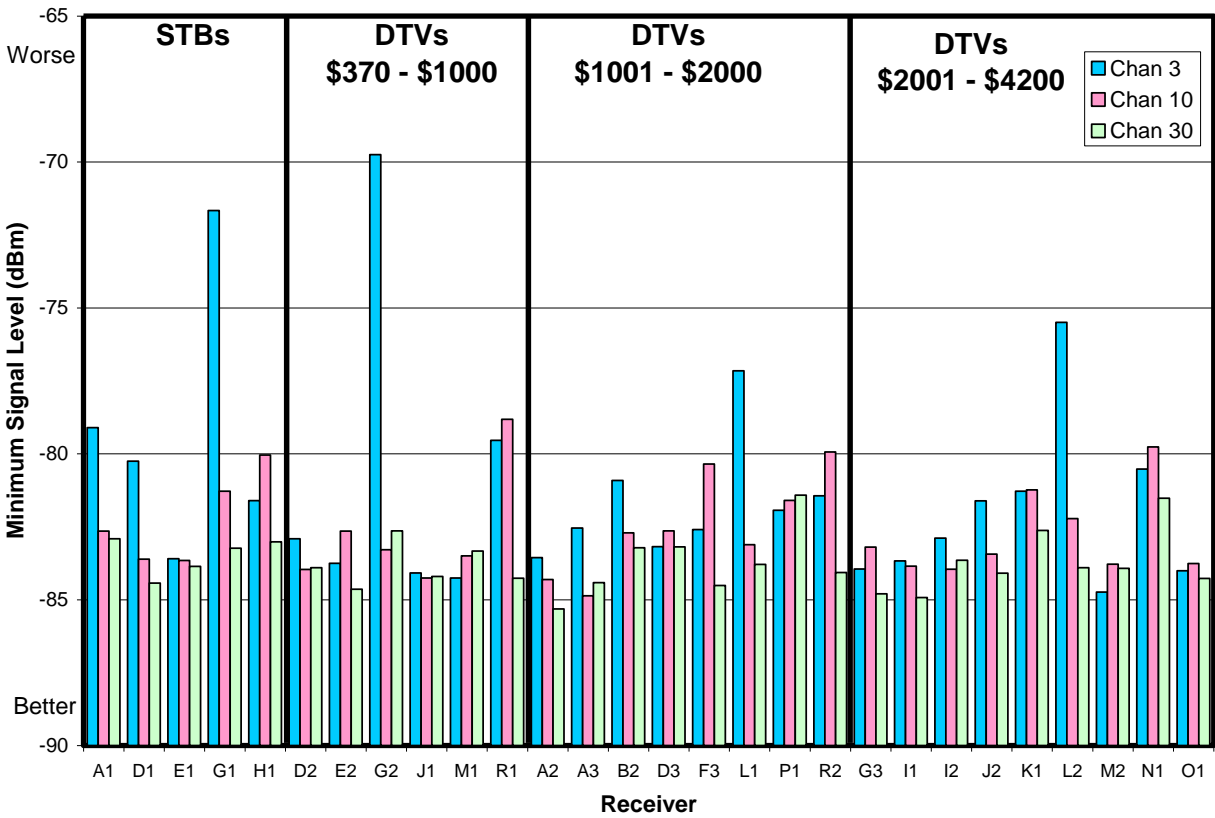

Figure 4-1. Measured Minimum Signal Level at TOV on Three Channels

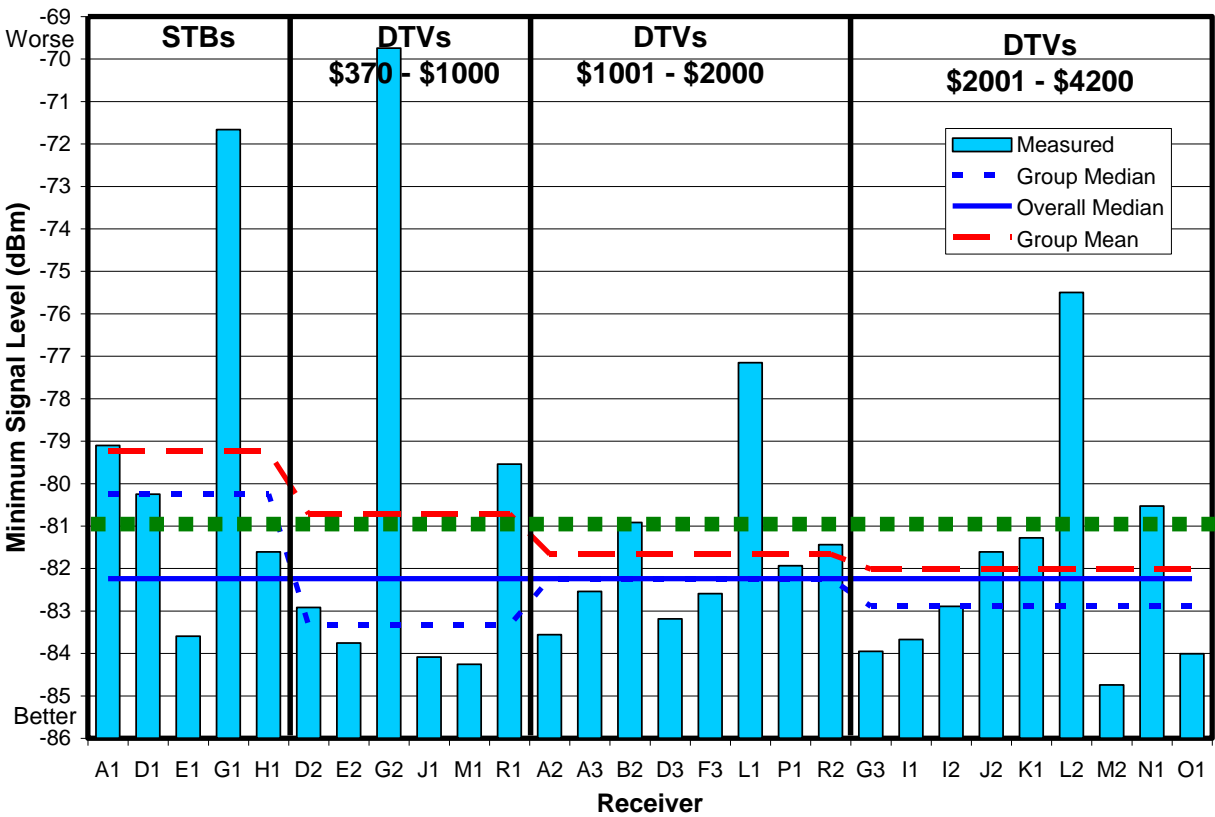

Figure 4-2. Measured Minimum Signal Level at TOV on Channel 3 (Low VHF)

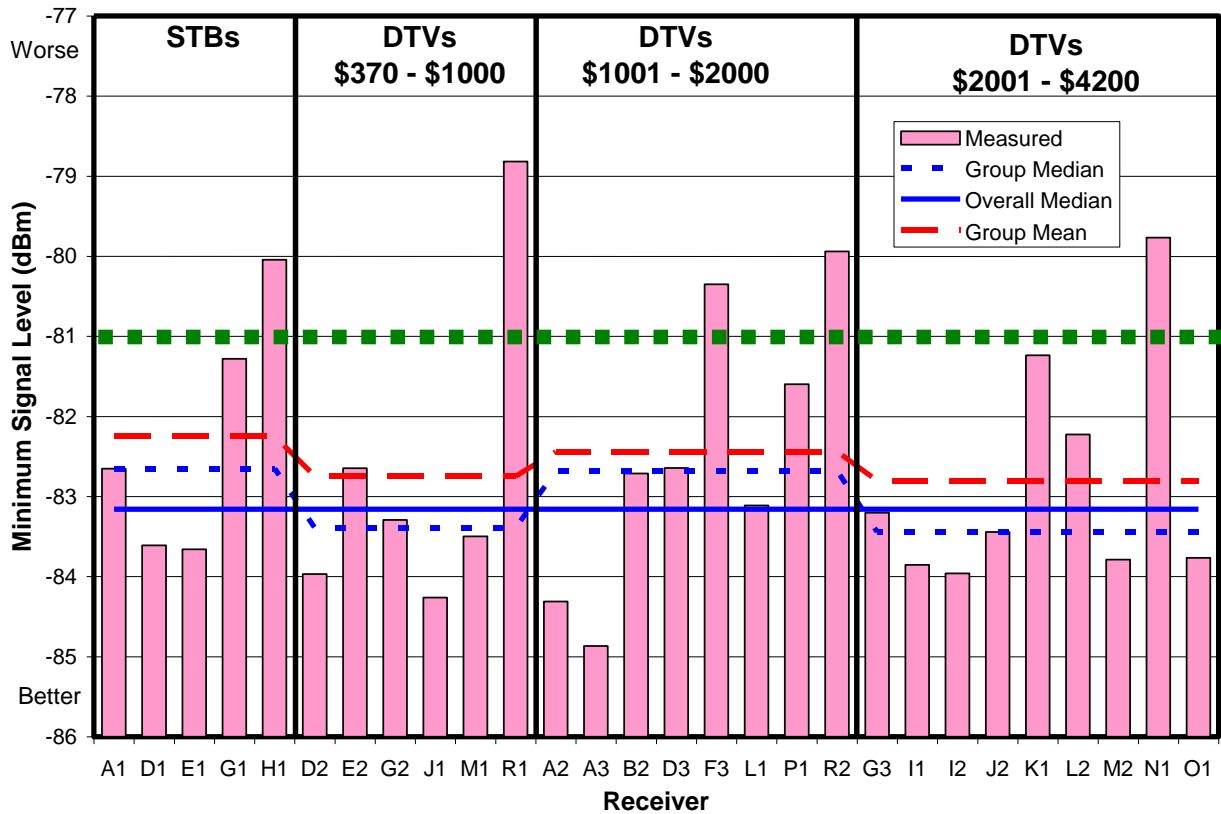

Figure 4-3. Measured Minimum Signal Level at TOV on Channel 10 (High VHF)

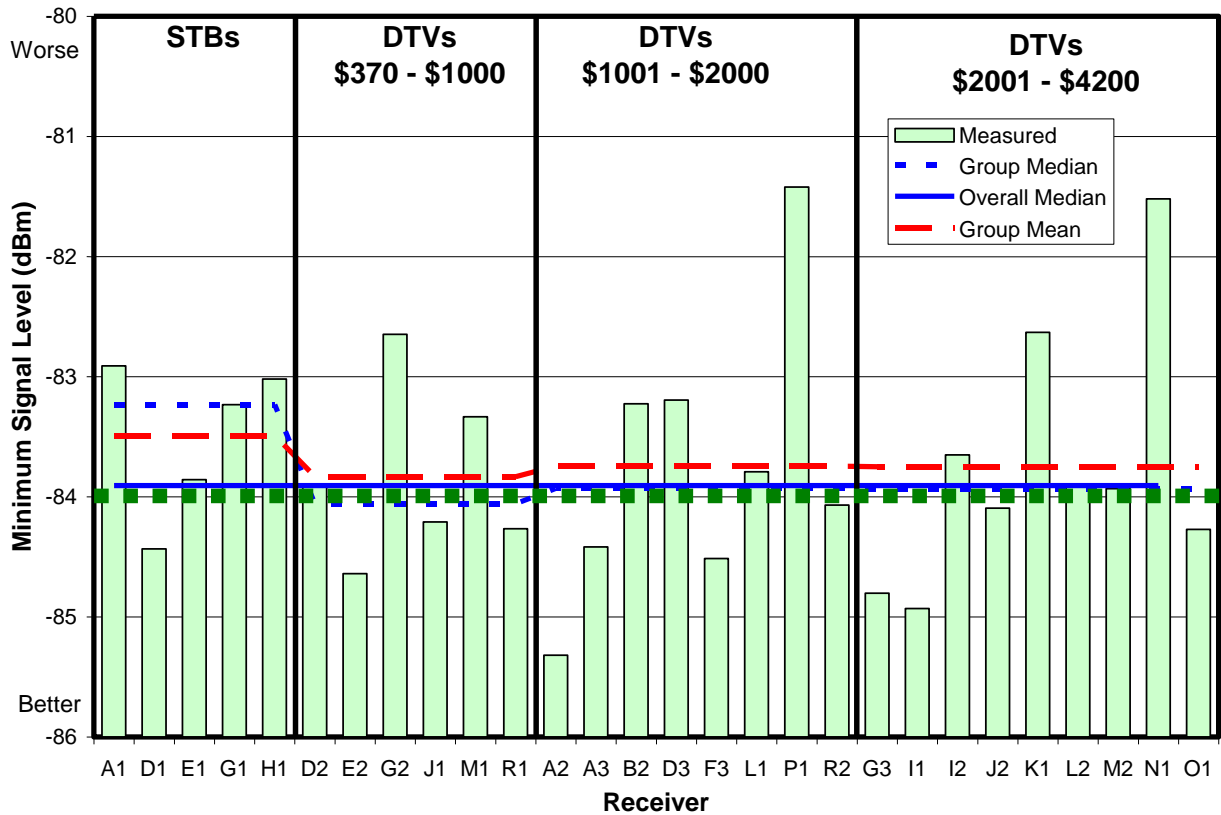

Figure 4-4. Measured Minimum Signal Level at TOV on Channel 30 (UHF)

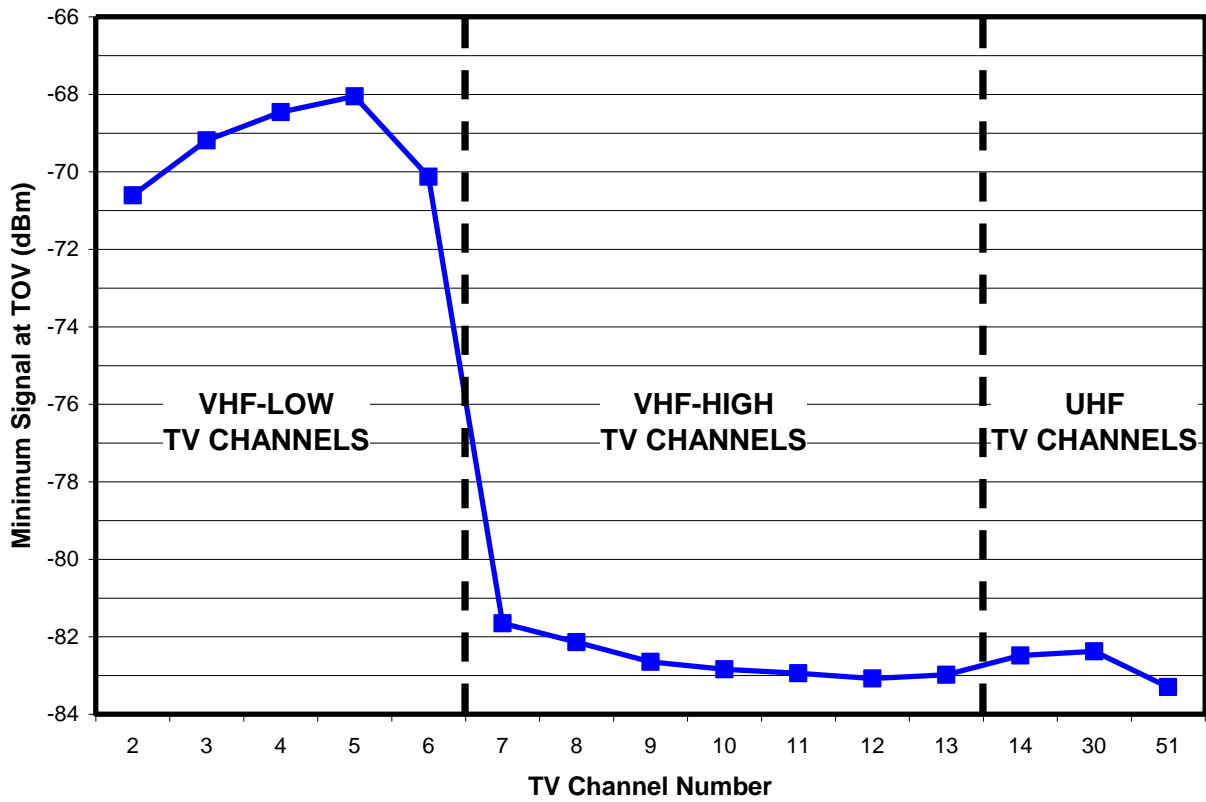

Figure 4-5. Measured Minimum Signal Level at TOV Versus Channel for Receiver G2

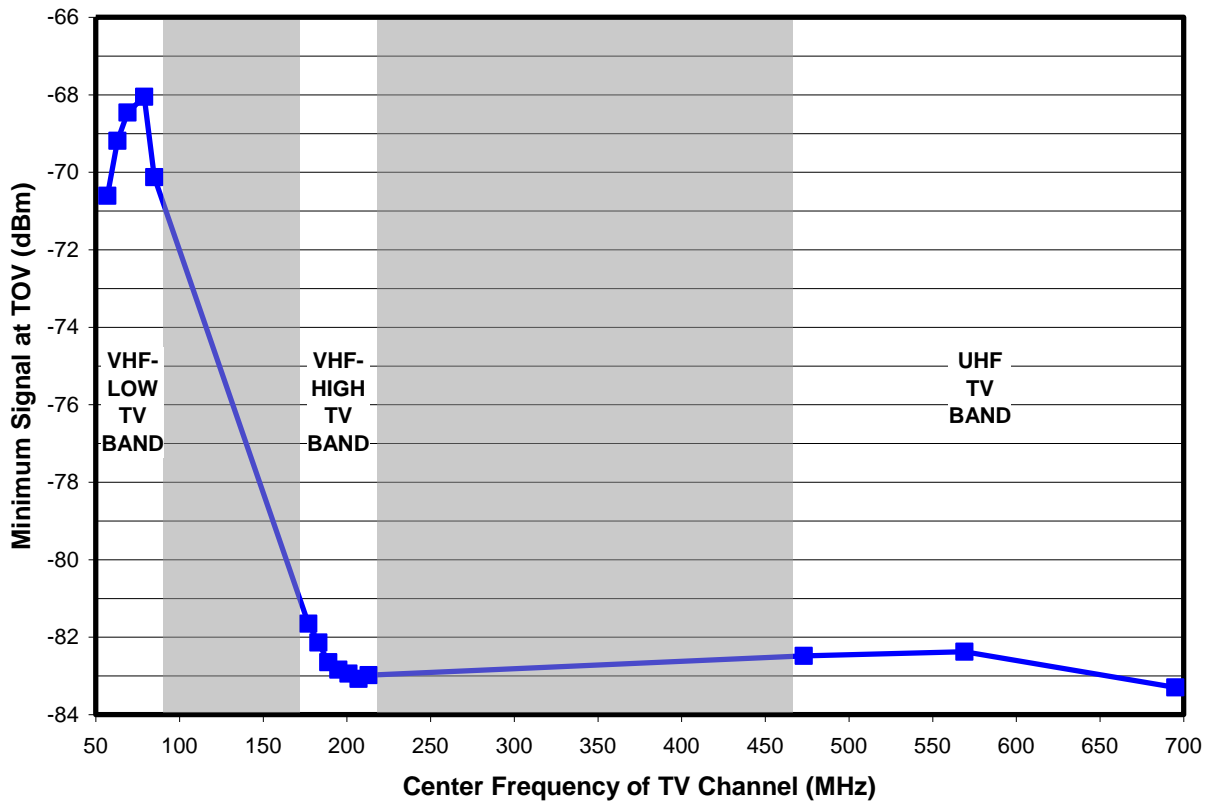

Figure 4-6. Measured Minimum Signal Level at TOV Versus Frequency for Receiver G2

CHAPTER 5

INFERRED NOISE FIGURE

The minimum signal level at TOV, presented in Chapter 4, can be viewed as the combined effect of two properties of the DTV receiver: the internal noise created by the receiver's input circuitry and the CNR required to produce a clean picture. Separating the measurement into those two basic terms provides a better understanding of the differences in performance between DTV receivers. It should be noted that this breakout is strictly valid only when reception sensitivity is limited by the receiver's amplifier noise, which we anticipate to be true for most receivers; however, if other factors limit reception sensitivity, the "inferred" receiver noise calculations in this chapter reflect those other performance limitations rather than actual receiver noise.*

The internal noise created by a receiver is often expressed in terms of noise figure. The noise figure of a receiver is the effective amount of noise created by the input circuitry of the receiver, measured relative to a physical limit on noise known as thermal noise and referenced to the input of the receiver. While noise figure cannot be directly measured externally, the effective noise figure can be inferred from the required CNR measurements of Chapter 3 in conjunction with the minimum signal level at TOV, as measured in Chapter 4.

Figure 5-1(a) illustrates measurement of required CNR (i.e., white noise threshold). The vertical line represents a range of signal and noise amplitudes that could be applied to the antenna terminal of a TV receiver. With external white noise added at a level well above the internal noise of the receiver, signal levels in the lower, red portion of the line will result in no TV picture. Signals in the yellow range will produce a picture degraded by demodulation errors. Signals in the green range, with signal level exceeding the noise level by an amount greater than the required CNR, will produce a picture free of reception-related defects. (The carrier-to-noise ratio (CNR), becomes a difference rather than a ratio, because of the logarithmic scaling implied by measurements in decibels.)

Figure 5-1(b) illustrates measurement of minimum signal at TOV, the minimum signal level required to achieve a clear picture absent any external noise. Assuming that the TV reception is limited by the receiver's broadband internal noise, this minimum signal level can be viewed as the sum (in dB) of two parameters—the internally generated noise level of the DTV receiver and the amount by which the signal must exceed that noise level, i.e., the required CNR. The noise level of the receiver can be expressed as the sum (in dB) of the noise figure of the receiver and the thermal noise at some reference temperature. Thus, we have

$$\text{Minimum Signal at TOV (dBm)} = \text{Thermal Noise (dBm)} + \text{Noise Figure (dB)} + \text{Required CNR (dB)}$$

Thermal noise is a function only of reference temperature and measurement bandwidth and is given by

$$\text{Thermal Noise (dBm)} = 10 \log(k T B) + 10 \log(1000 \text{ mW/W})$$

where

$$k = \text{Boltzmann's constant} = 1.38065 \times 10^{-23} \text{ joules/}^\circ\text{K}$$

* Various receiver design anomalies could result in reception sensitivity being limited by factors other than receiver noise (noise figure). For example, if the AGC (automatic gain control) does not allow sufficient RF and IF gain to amplify a weak signal to the level necessary for demodulation, reception performance will be limited by gain rather than by amplifier noise. Similarly, receiver performance could also be limited by local oscillator phase noise or by leakage into the tuner of internally-generated interference sources such as impulse noise from digital circuits or narrowband (tonal) interference.

T = reference temperature in degrees Kelvin (290°K for this report)*
 B = the measurement bandwidth = 6,000,000 Hz for a television channel
 10 log(1000 mW/W) provides the conversion from dBWatts to dBmilliwatts

Using the above values, thermal noise = -106.2 dBm.

If the noise generated internally by the DTV receiver is similar to white Gaussian noise, then the required CNR in Figure 5-1(a) is the same as that in Figure 5-1(b); consequently, noise figure of the receiver can be computed as

$$\text{Noise Figure (dB)} = \text{Minimum Signal at TOV (dBm)} - \text{Required CNR (dB)} - \text{Thermal Noise (dBm)}$$

RESULTS

The noise figures for all tested receivers on the three tested channels have been computed as above and are shown in Figure 5-2. Individual results for TV channels 3, 10, and 30 are shown in Figures 5-3, 5-4, and 5-5, respectively. The general format of the plots is as described in Chapter 3 in the section titled, “Format of the Bar Graph Data”, except that, in the case of Figure 5-2, there are three bars per DTV receiver—representing the three channels tested. The reader should note the differences in vertical scales among the four graphs.

Note that in performing the noise figure calculation, the required CNR is assumed to be constant across the TV channels for the reasons discussed in the “Effect of TV Channel” section of Chapter 3. Thus, the CNR measurements on channel 30 are applied to channels 3 and 10, as well.

Nominal Noise Figure and Variation Among Samples

Table 5-1 shows the statistical properties of the noise figure across all tested receivers.

Table 5-1. Statistics of Receiver Noise Figure

| NOISE FIGURE | Chan 3 | Chan 10 | Chan 30 |
|---|--------|---------|---------|
| Median across all receivers (dB) | 8.8 | 7.6 | 6.9 |
| Median re OET-69 planning factors | -1.2 | -2.4 | -0.1 |
| Deviations of receivers from median | | | |
| --Best performing receiver (dB) | -2.5 | -1.3 | -1.3 |
| --Worst performing receiver (dB) | 12.2 | 4.5 | 2.6 |
| --89 th percentile receiver (dB) | 4.5 | 3.3 | 1.2 |
| Standard deviation (dB) | 3.6 | 1.6 | 0.9 |
| Total span from worst to best receiver (dB) | 14.7 | 5.7 | 3.9 |

The median noise figure across all measured receivers was found to decrease with channel—with the noise on channel 30 being 1.9 dB lower than that on channel 3. The median noise figures were 1.2 to 2.4 dB better than those shown in the OET-69 planning factors for the VHF bands (10 dB) and essentially matched the planning factor for the UHF band (7 dB).

* The reference temperature is generally taken as the antenna temperature. 290°K = 17°C = 62°F results in a thermal noise level matching the -106.2 dB value used in OET-69.

On channel 3, only 21 percent of the tested receivers performed more poorly in noise figure than the value modeled in OET-69 by an amount exceeding 1-dB—the approximate tolerance of the measurements.* On channels 10 and 30, the numbers are 7 percent and 18 percent, respectively.

The variations among receivers were large on channel 3—with a 3.6 dB standard deviation and two receivers performing at levels 10.3 and 12.2 dB worse than the median. More attention to tuner design for those two receivers might significantly improve performance in weak signal conditions. 89 percent of the receivers (all but three) were no more than 4.5 dB above (worse than) the median noise figure.

Variations were relatively small on channels 10 and 30. Standard deviation across all receivers was 1.6 dB on channel 10 and 0.9 dB on channel 30. The worst performers differed from the median by 4.5 and 2.6 dB, respectively, on channels 10 and 30, and 89 percent of the receivers (all but three) were no more than 3.3 dB above (worse than) the median noise figure on channel 10 and no more than 1.2 dB above the median noise figure on channel 30.

Variation With Product Type and Price

Magnitude of Observed Variations With Product Type and Price

As can be seen in Table 5-2, the observed variations in receiver noise figure with product type and price categories were very small (category medians differing from overall median by less than 1 dB) for channels 10 and 30 and were somewhat larger for channel 3. On channel 3, median noise figure of set-top boxes was 1.7 dB worse than the overall median of all receivers. The best median noise figure—1.4 dB better than the overall median—occurred in the low-price DTV category. Such differences are likely to influence performance only in locations where the signal margin is very small.

Table 5-2. Product-Type/Price Variations of Receiver Noise Figure

| NOISE FIGURE | Chan 3 | Chan 10 | Chan 30 |
|--|-------------------|--------------------|--------------------|
| Median of Set-Top Boxes re Overall Median (dB) | 1.7 | 0.1 | 0.6 |
| Median of Low-Price DTVs re Overall Median (dB) | -1.4 | -0.1 | 0.0 |
| Median of Medium-Price DTVs re Overall Median (dB) | 0.0 | 0.4 | -0.1 |
| Median of High-Price DTVs re Overall Median (dB) | -0.8 | -0.3 | 0.0 |

Statistical Significance of Observed Variations With Product Type and Price

Table 5-3 shows the Pearson’s correlation coefficient between the noise figure and the price of each DTV receiver. Given the similarity of results with those for minimum signal at TOV, the reader is referred to Chapter 4 for a discussion of the interpretation of these results. The bottom line is that there is no statistically significant correlation of noise figure with price of the receivers..

* Absolute measurement accuracy of the vector signal analyzer on the amplitude range that was used for the measurements was as ± 1.5 dB maximum and ± 0.5 dB typical.

Table 5-3. Correlation Coefficient of Receiver Noise Figure with Price

| Pearson's Correlation Coefficient of Noise Figure with Price | Chan 3 | Chan 10 | Chan 30 |
|---|---------------|----------------|----------------|
| All Tested Receivers | -14% | -4% | +6% |
| DTVs Only (no Set-Top Boxes) | -1% | -1% | +11% |

Relative Variations in Noise Figure and Required CNR

Figure 5-6 shows the required CNR for each receiver as a function of noise figure on each of the three tested channels. Contour lines can be used to read the combined effect of the two parameters on minimum signal at TOV. It is clear from the plot that most of the variation in receive sensitivity (i.e., minimum signal level at TOV) of the DTV receivers is due to variations in receiver noise figures rather than variations in the CNR required by the demodulator. In fact, based on standard deviations of the parameters, variability in noise figure among the receivers is 4.2 times as high as the variability in required CNR on channel 30, where the noise figure variations are smallest. On channels 10 and 3, respectively, the noise figure shows 7 and 16 times the variability of required CNR.

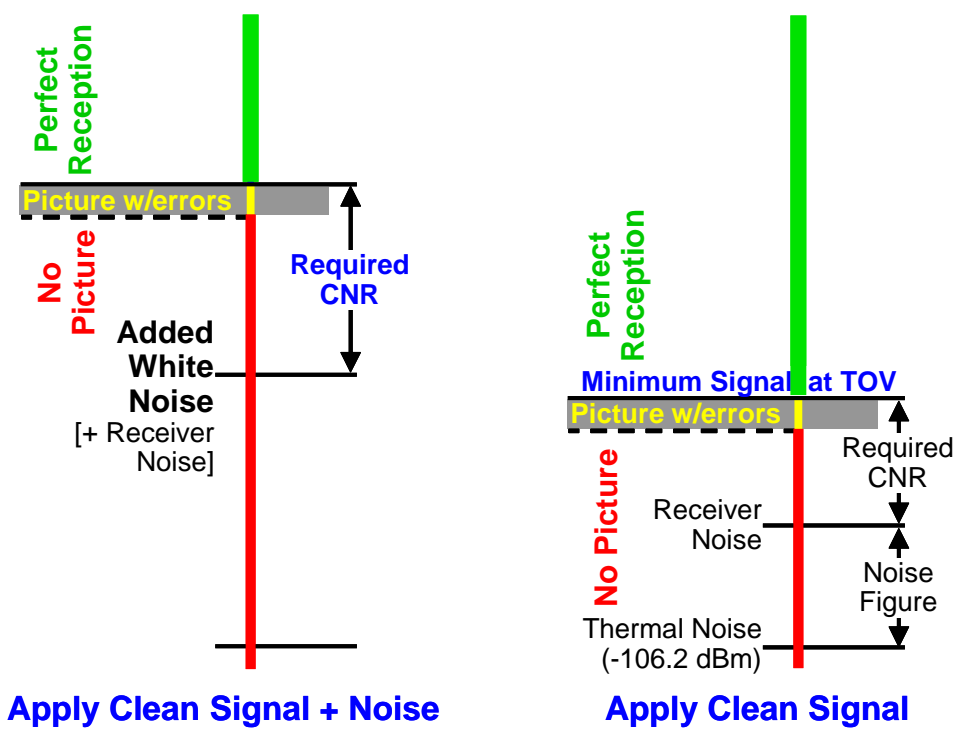

Figure 5-1. Relationship between Minimum Signal at TOV and Required CNR

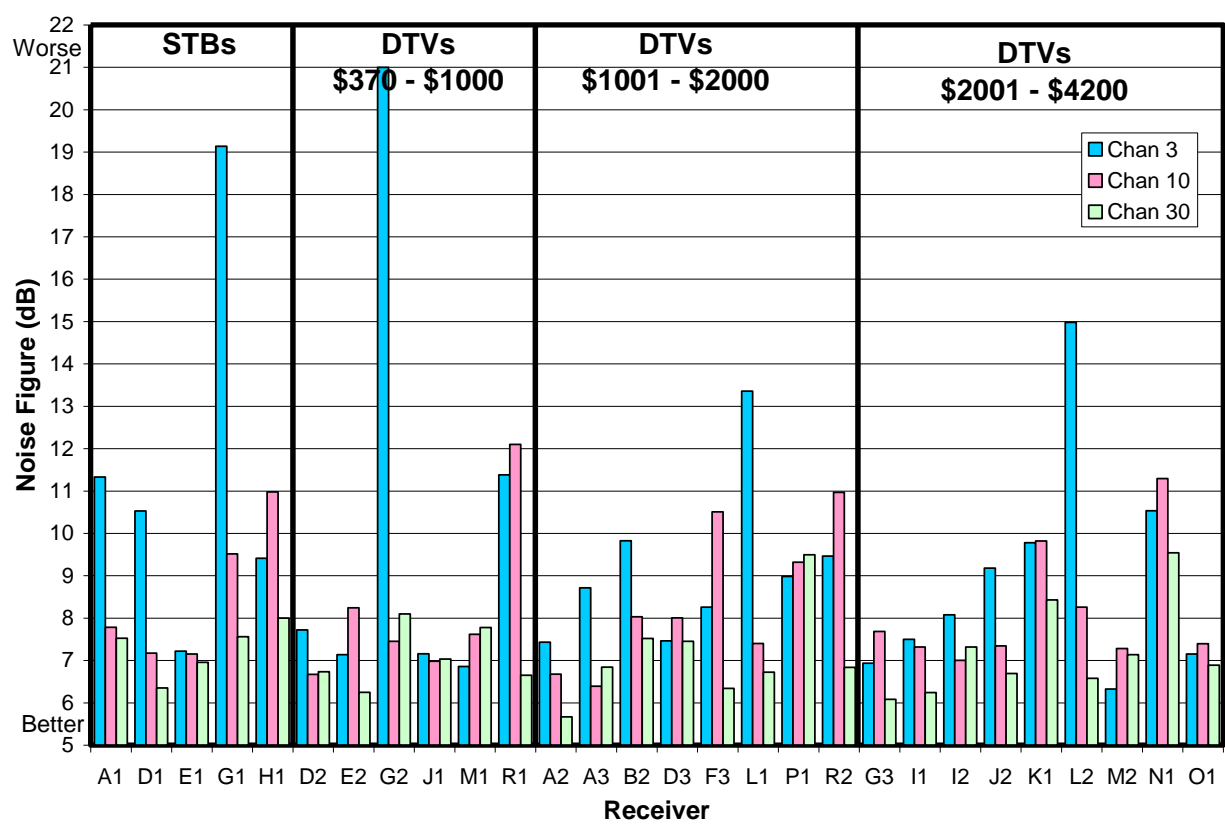

Figure 5-2. Noise Figure on Three Channels

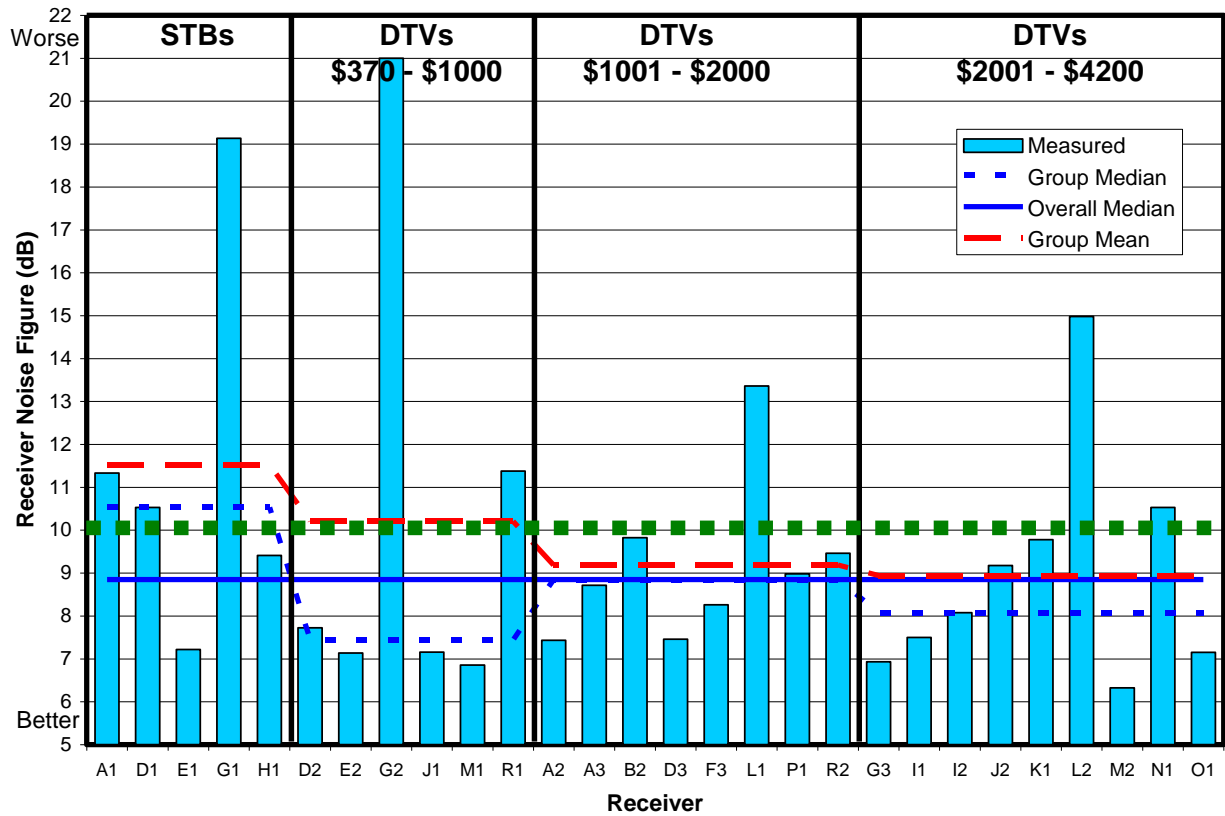

Figure 5-3. Noise Figure on Channel 3 (Low VHF)

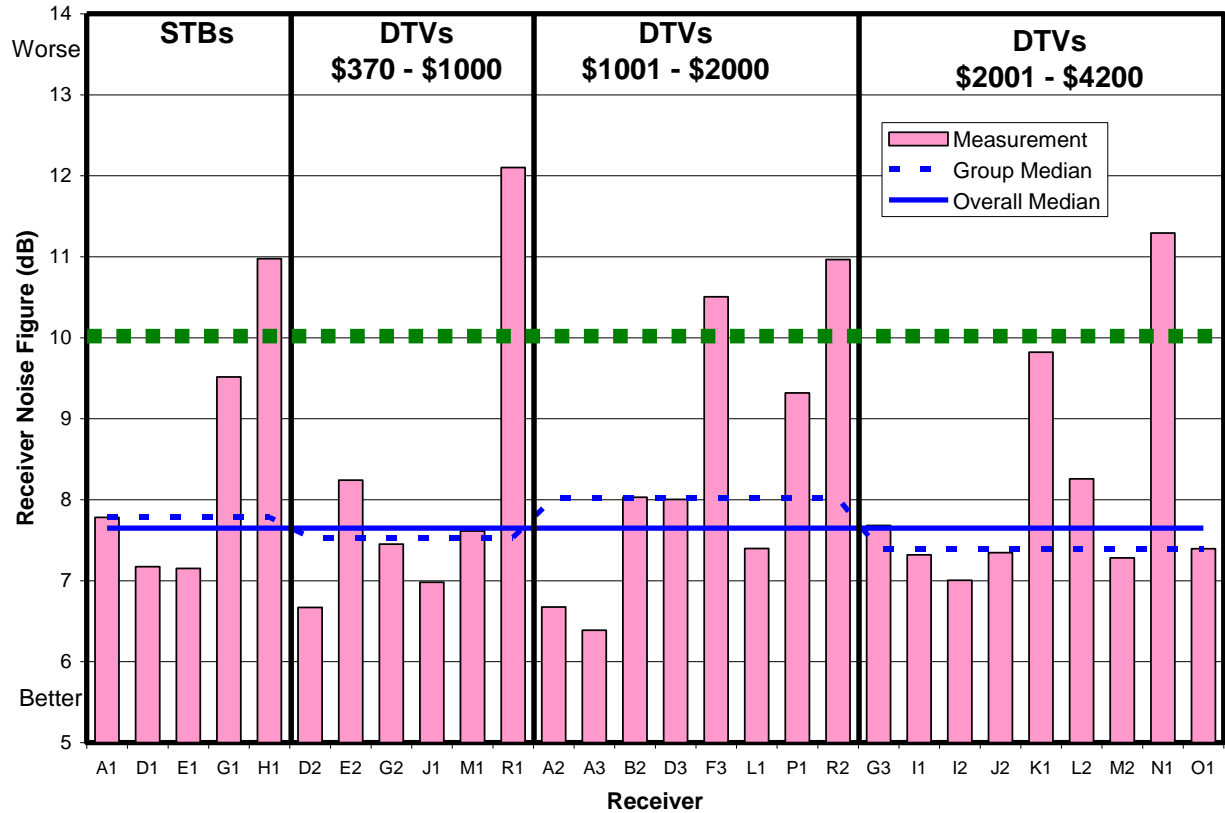

Figure 5-4. Noise Figure on Channel 10 (High VHF)

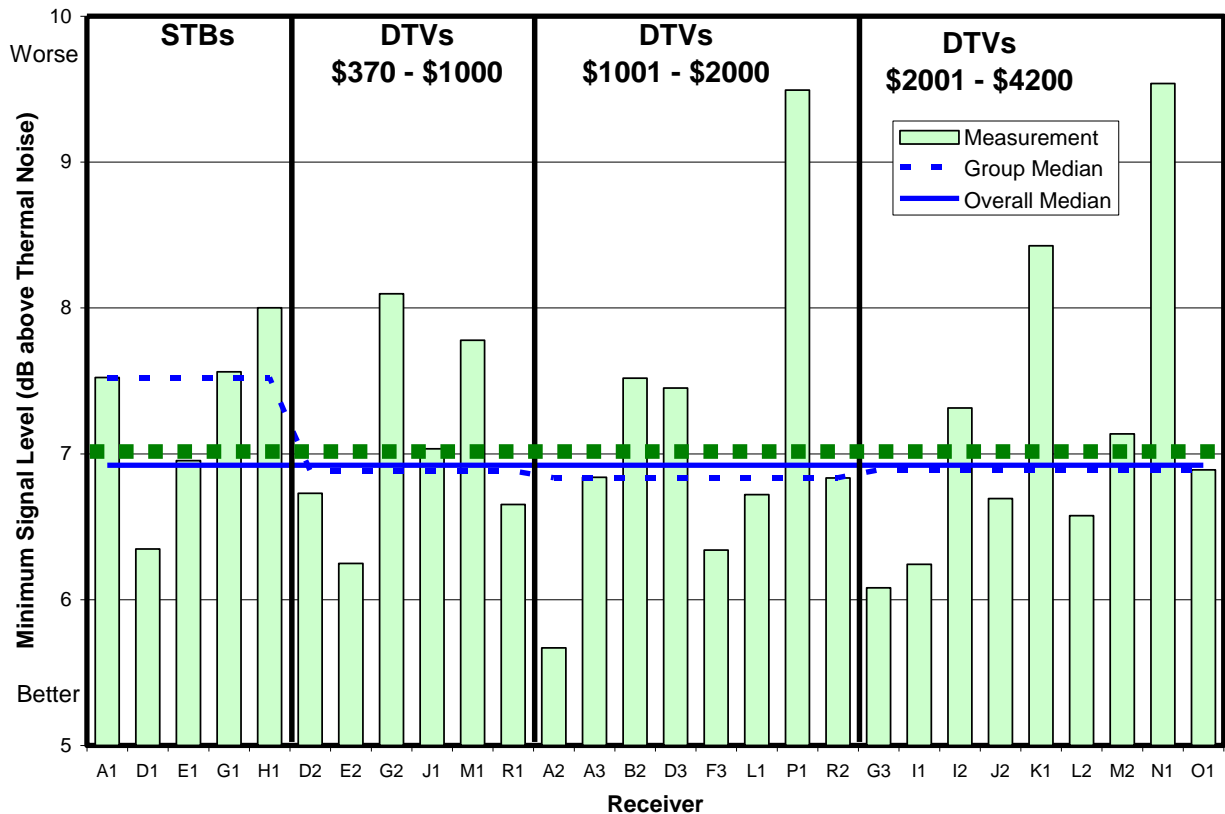

Figure 5-5. Noise Figure on Channel 30 (UHF)

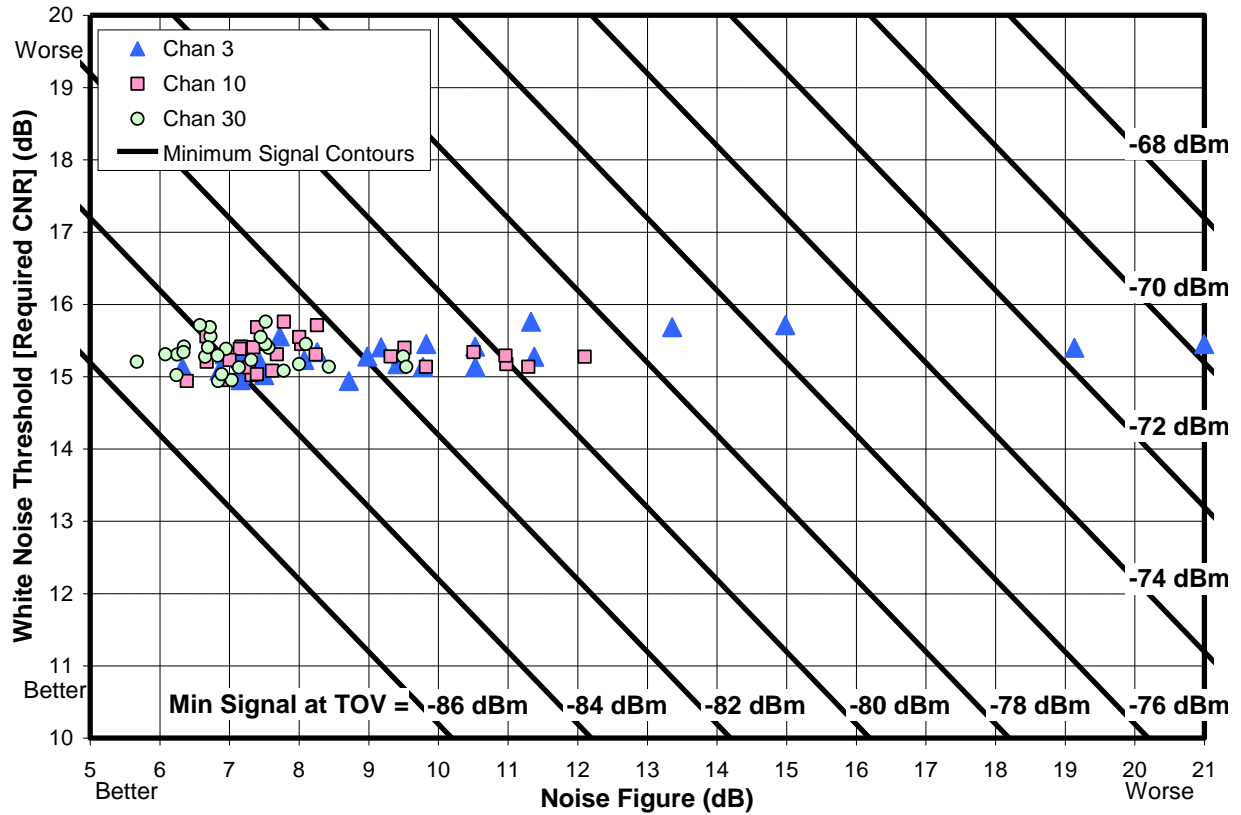

Figure 5-6. Required CNR Versus Noise Figure

CHAPTER 6

PERFORMANCE AGAINST MULTIPATH USING FIELD CAPTURES

Chapters 3 through 5 dealt with over-the-air reception performance of the DTV receivers with a signal that is unimpaired by multipath. Chapter 6 addresses the issue of multipath by determining the ability of each receiver to process broadcast DTV signals that were received and recorded on actual television antennas at various locations in New York City and Washington, DC.

The selected digital RF recordings, also called “captures” or “field ensembles”, were 47 of the 50 captures recommended by the ATSC for DTV receiver testing.^{*} ATSC’s characterization of the 50 captures is worth noting.

“Most of the field ensembles contain data captured at sites where reception was difficult. The field ensembles are clearly not meant to represent the statistics of overall reception conditions but rather to serve as examples of difficulties that are commonly experienced in the field.”[†]

Three of the 50-recommended captures were excluded from testing with the consumer DTV receivers because they contain no video content and therefore require specially instrumented receivers for testing; however, extrapolation of instrumented receiver test results for those three captures to the consumer receivers is discussed later in this chapter. The remaining 47 captures break down as follows:

- sites characterized as urban (19), suburban (12), rural (2), and various other categories that overlap these designations (14);
- single-family homes (18), townhouses (8), and apartments (21);
- indoor antennas (39) and outdoor log-periodic antennas (8)

Each of the captures was recorded in the year 2000 by the Advanced Television Test Center (ATTC) or the Association for Maximum Service Television (MSTV) using specialized digital capture equipment. Each capture has duration of either 23 or 25 seconds. An RF player allows the recorded signal to be translated to any standard TV broadcast channel and played back as a repeating loop.

Appendix B lists the captures and summarizes some of the test results.

MEASUREMENT METHOD

The test configuration was essentially the same as that described in Chapter 3, for the white-noise threshold measurements, except that no noise was injected. The nine-way splitter allowed the signal to be simultaneously applied to as many as eight DTV receivers and a vector signal analyzer. All 47 selected RF captures were played through each group of receivers. Performance is reported in this chapter as the number of captures successfully played by a receiver for two different criteria of success. As a consistency check, receiver D3 was included in each group of eight receivers that were tested; the numbers of captures played successfully on receiver D3 on the various tests were consistent within one count.

Signal attenuators were adjusted to provide a nominal input of -30 dBm at the receiver antenna ports. The attenuator was not separately adjusted for each capture file; consequently, the actual injected level within

^{*} “ATSC Recommended Practice: Receiver Performance Guidelines”, ATSC Doc. A/74, Advanced Television Systems Committee, 17 June 2004.

[†] Ibid., p. 15.

the channel bandwidth of 6 MHz. varied from -38 to -28 dBm based on the level recorded in each capture. All but four of the captures played at an in-channel level within 2 dB of the nominal.

Successful playback of a capture was defined in terms of the number of video error bursts observed during a single playback loop after the loop had played at least three times. (In many cases the performance was monitored over several loops and, if the results varied, a median value was chosen.) A video error burst lasting more than one second was counted based on the approximate duration in seconds. Thus, an error burst lasting three seconds was counted as three errors. Errors occurring during or immediately after the loop-restart time were not counted, nor were errors associated with known defects (dropped symbols) in eight of the captures, as documented by the ATSC.*

The testing was performed on channel 30. It should be noted that with many of the DTV receivers, simply tuning to channel 30 was not sufficient to ensure successful acquisition of the TV signal—even with one of the easier captures. The original source material for the captures was recorded from eight different DTV broadcast stations in two cities. Because of the facts that multiple programs can be broadcast on a single channel and that most DTV channels are associated with an equivalent analog channel number that is used in selecting the station (PSIP requirements),† many of the receivers were “confused” by changing broadcast stations from playback of one capture to playback of the next, even though the RF channel remained constant. As a result, various methods such as rescanning the channels were necessary to get many of the receivers to operate after changing between captures that originated on different TV channels. To save time in the process, the captures were sorted by originating broadcast station before testing, and were further sorted to allow the more benign captures from a given broadcast station to be played first, in order to lock the receivers onto each new broadcast station.

Further details on the measurement procedure are contained in Appendix A.

RESULTS

Figure 6-1 shows the results of testing each DTV receiver with each of the 47 RF captures. The general format of the plot is as described in Chapter 3 in the section titled, “Format of the Bar Graph Data”, but with a few differences. The blue (lower) portion of each bar represents the number of captures that played without a visible error during a single loop of the capture. The upper portion of each bar adds the captures that played with no more than two visible errors during a single loop of capture.

It should be noted that, unlike the plots presented in earlier chapters of this report, increased performance in this plot is represented by taller bars. Also, in addition to the four category groupings of DTV receivers, Figure 6-1 includes an additional bar on the right, labeled 2000REF. This receiver was retained from field testing in the year 2000 and was included in the RF capture testing presented here. Further discussion of this receiver is provided later in this chapter as well as in Chapter 7.

Nominal Performance and Variation Among Samples

Unlike the results of other testing presented in this report, the results of testing against the RF captures are heavily clustered into two major performance tiers. The upper-tier (better) performers successfully played about 29 captures without error and about 37 captures with two or fewer errors. The lower-tier

* See Table B-1 of this report or the “Quality of Capture” column of the continuation of Figure A-1 on p.28 of “ATSC Recommended Practice: Receiver Performance Guidelines”, ATSC Doc. A/74, Advanced Television Systems Committee, 17 June 2004.

† The Program and System Information Protocol (PSIP) includes a field for establishing this association. Further information is available in Advanced Television Systems Committee documents A/65B “ATSC Standard: Program and System Information Protocol for Terrestrial Broadcast and Cable (Revision B)” and A/69 “ATSC Recommended Practice: Program and System Information Protocol Implementation Guidelines for Broadcasters” for more information.”

performers successfully played about 7 captures without error and about 9 with two or fewer errors. Neglecting receivers D1 and L2, all results fall within ± 2 captures of one of these nominal results, as shown in Table 6-1. Receivers D1 and, perhaps, L2, appear to represent an additional performance tier slightly above the lower tier; this tier will be designated as “lower tier+”.*

The upper-tier performers represent a quantum leap in ability to handle the most difficult multipath conditions. The receivers that tested in this tier are known to include the latest generation of demodulator chips from at least two of the major DTV chip developers.

Table 6-1. Number of Captures Successfully Played By Each Performance Tier

| | Number of Consumer Receivers | Number of Captures Played with No Errors | Number of Captures Played with No More Than 2 Errors |
|-------------|------------------------------|--|--|
| Lower Tier | 16 | 7 \pm 2 | 9 $+2/-1$ |
| Lower Tier+ | 2 | 8 and 12 | 14 and 16 |
| Upper Tier | 10 | 29 \pm 2 | 37 \pm 2 |

It should be noted that some of the RF captures may contain recording flaws—other than the dropped symbols discussed earlier—that could prevent error-free demodulation regardless of how advanced the demodulator technology may be. For example, four of the captures for which no tested receiver achieved demodulation free of visual errors were identified by the ATSC as having possible non-linearities caused by high-level adjacent channels overdriving the recording system. These or other potential flaws may preclude a 100% success rate on the 47 captures from ever being achieved by any demodulator; consequently, we view the multipath-performance data based on these captures to be useful for purposes of comparing receivers, but not as an absolute measure of performance.

Extrapolation to the Three Captures Lacking Video Content

Three of the ATSC-recommended RF captures lacked video content and could not, therefore, be tested with the consumer DTV receivers; however, they were tested with a five-year-old instrumented DTV receiver, labeled “2000REF” in Figure 6-1. That receiver provides visual and audible indications when segment errors[†] occur during demodulation of the DTV signal.

Tests were performed first using three captures with video content (labeled as numbers 27, 29, and 45 in Appendix B). These captures exhibited 4, 1, and 2 visual errors, respectively, with the 2000REF receiver. Results showed a one-to-one correspondence of segment error bursts with observed video error bursts for these captures.[‡]

Tests of the 2000REF receiver with the captures having no video content (labeled 22, 24, and 44 in Appendix B) showed no segment errors. The absence of segment errors indicates that the 2000REF receiver would have exhibited no visible errors on these captures had there been video content to observe. Given that this five-year-old receiver—now obsolete by two demodulator generations—is among the worst performing of the tested receivers in terms of multipath performance (per Figure 6-1), it is

* Receiver D1 belongs in the “lower tier+” category because it performed above the range of performance for the lower tier both in terms of number of captures played with no errors and number of captures played with two or fewer errors. The case for placing receiver L2 in the “lower tier+” category rather than in the lower tier is weaker, since only one of its performance numbers (number of captures played with two or fewer errors) was above the lower tier range.

[†] With 8-VSB, each transmission segment consists of one MPEG packet. Thus, a segment error is equivalent to an MPEG packet error.

[‡] In general, visual errors are expected to occur only when segment errors occur, but the reverse is not always true, depending on effectiveness of MPEG error concealment algorithms for the video content at the time of the errors.

considered likely that all of the tested consumer receivers would have exhibited no visual errors for these three captures had there been video content to observe. Consequently, if one wanted to extrapolate performance against the entire set of 50 ATSC-recommended RF captures from the tests of the 47 with video content, it is likely that three zero-error successes should be added to the results for each receiver.

Variation With Product Type and Price

Interestingly, both upper-tier and lower-tier performers appear in all three price categories of DTVs. This suggests that performance is not a function of price—at least in the DTV category.

On the other hand, none of the set-top boxes—the least expensive way to receive a digital broadcast if you connect it to an existing television—perform at the upper tier level.

Some understanding of these results can be achieved by looking at the introduction date of each tested receiver to the U.S. market. Introduction dates (by month and year) for 25 of the 28 receivers tested for this report were provided by the manufacturers; the remaining three were determined by a web search. Though introduction dates are not reported here in order to avoid possible date-based linking of individual product models with the receiver designations used in this report, the following observations are relevant.

- All ten upper-tier performers were introduced in or after March, 2005.
- The set-top boxes—all of which performed at the lower tier or “lower tier+”—were introduced in or before November, 2004.
- Of the lower-tier or lower-tier+ integrated DTVs (i.e., excluding set-top boxes), two were released in the latter part of 2004 and the remaining eleven were introduced between March and July, 2005.

Since the set-top box models available on the market at the time of the reported tests were 2004 or earlier models,* their lower-tier or “lower-tier+” performance reflects the lack of availability of the newer generation of DTV demodulator chips at the time of product design.

Among the DTVs, it is clear that introduction dates in or after March 2005 are consistent with feasibility of including of the newer technology. Among the tested DTVs that were introduced in or after March 2005, 48 percent performed at the upper tier level. It is probable that some of the products introduced in this time frame carried over tuner/demodulator designs from a previous generation.

One would expect that, as future models are released, the newer generation demodulator technology will migrate to an increasing extent into all DTV product categories, including set-top boxes, and that, at some point in the near future, the improved technology will be contained in all newly introduced receivers. In the meantime, there is little publicly available information to assist those consumers who live in locations characterized by challenging multipath conditions in selecting DTV receivers that achieve the upper tier of performance.

Relationship Between Multipath Performance and White Noise Threshold

There is some reason to expect that improvements in multipath performance—which is achieved in part by increasing the number of taps in the demodulator’s equalizer circuit—might come at the expense of poorer white noise threshold, because, even in the absence of multipath, the additional taps could be expected to add noise that is related to carrier amplitude. (Since an automatic gain control would be expected to provide sufficient gain to amplify the input signal—whatever its level—to a fixed level for processing by the demodulator, one would expect that the tap noise generated after this variable amplification would be at a fixed level relative to the DTV signal rather than at a fixed level relative to

* One of the tested set-top-box models was released to the market in August 2003. The other four were released between July and November 2004.

the antenna input—hence the impact would appear as a degradation to required CNR [white noise threshold] rather than an increase in noise figure.)

Figure 6-2, shows the measurements of white noise threshold (from Chapter 3) plotted against multipath performance as measured by the number of RF captures (out of 47) that were successfully played without error. The lower tier of multipath performers (presumably containing earlier generation 8-VSB decoders) had a median CNR threshold of 15.3 dB,^{*} which is slightly worse than the 15.19 dB threshold achieved by the ACATS Grand Alliance prototype receiver.[†] Until the most recent VSB decoder generation came to market, the trend of the earlier VSB decoder improvements was a very slight worsening of the CNR at threshold as a tradeoff for improved multipath performance. The 15.1 dB median CNR threshold for the upper tier of multipath performers suggests that this trend is over. In fact, the seven best-performing receivers in terms of white noise threshold are in the upper tier of multipath performance.

^{*} 15.3 dB is the median value for those receivers identified as lower tier—not including those identified as “lower tier+”. If the lower tier+ receivers are included, the median is 15.4 dB.

[†] “Final Technical Report”, Federal Communications Commission Advisory Committee on Advanced Television Service (ACATS), October 31, 1995, p.19.

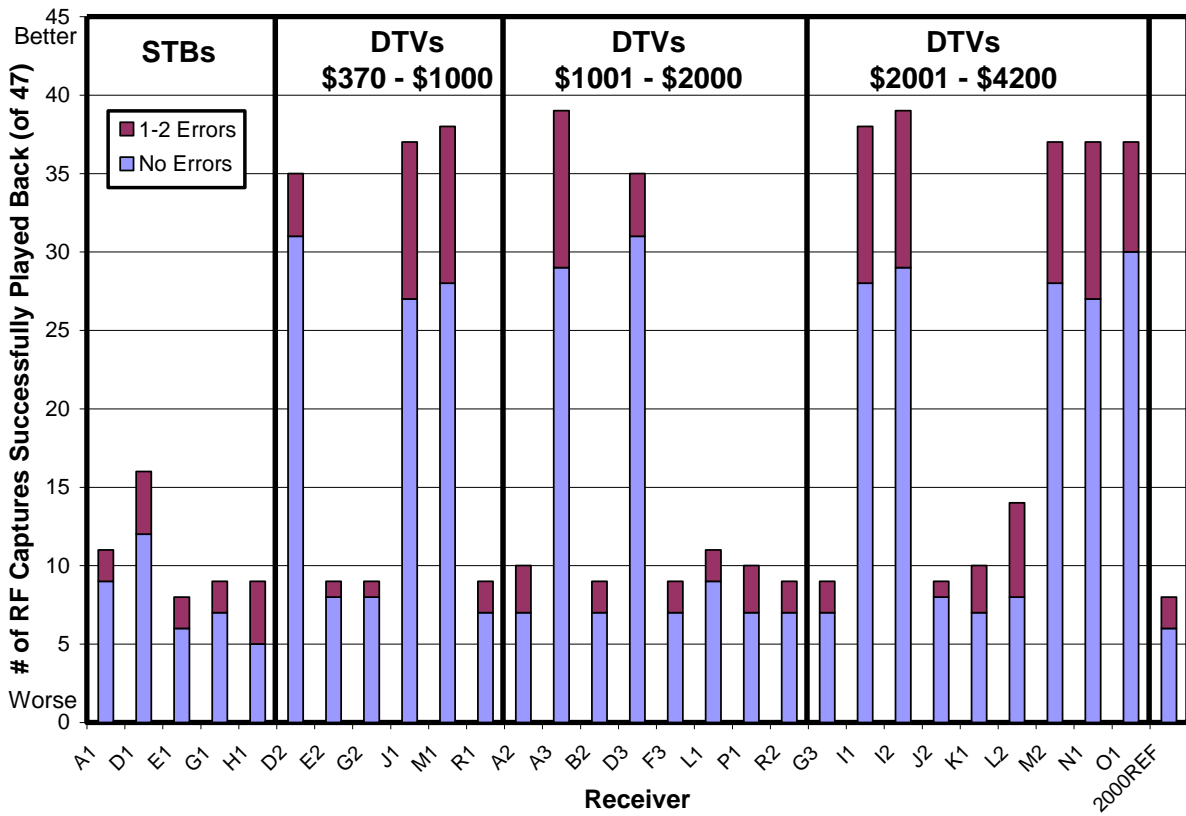

Figure 6-1. Performance Against 47 RF Captures

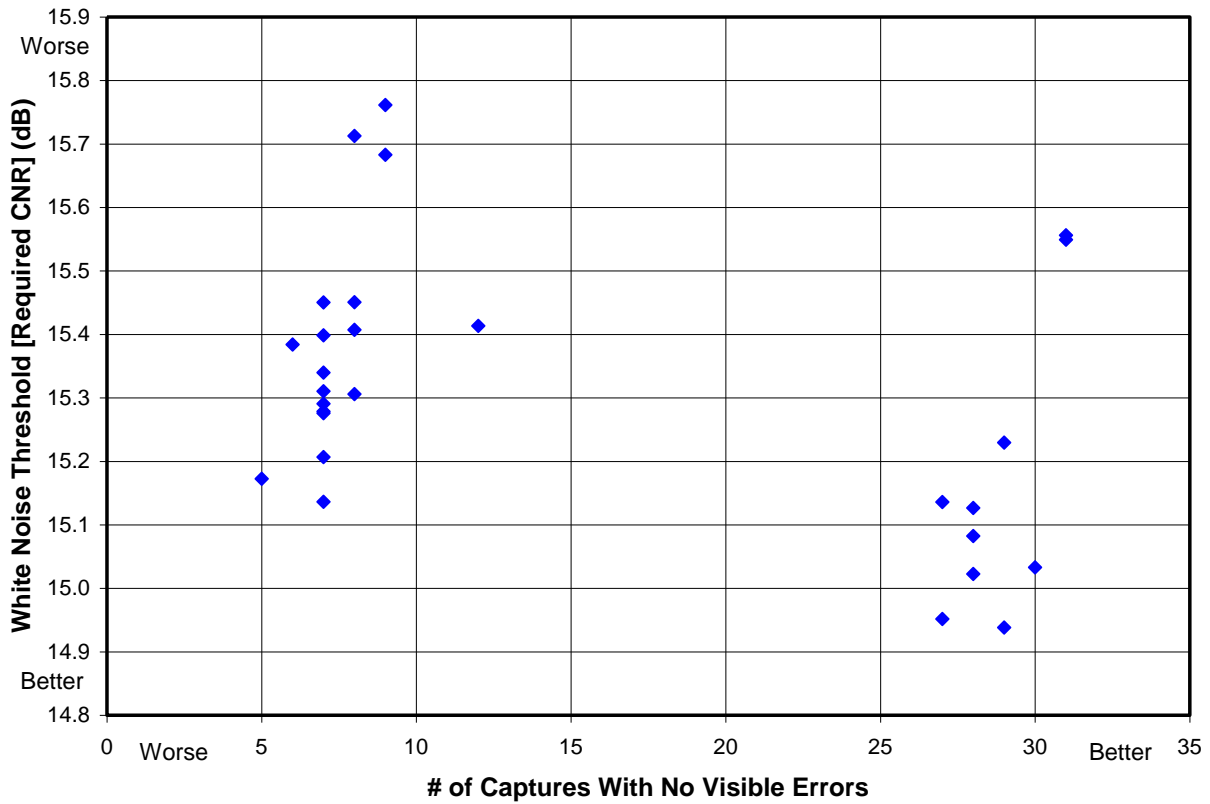

Figure 6-2. White Noise Threshold Versus Multipath Performance

CHAPTER 7

INFERRED PERFORMANCE AGAINST REPRESENTATIVE MULTIPATH CONDITIONS

The measurements presented in the previous chapter show that DTV receivers on the market at the time of these tests differ markedly in their ability to handle certain difficult multipath conditions. In order to understand the impact of these differences, one would also like to know how prevalent are the types of multipath conditions that differentiate receiver performance. If those conditions occur only rarely, then the performance differences will not be of consequence to most consumers; on the other hand, if they occur frequently, then the performance differences between “upper tier” and “lower tier” performers will radically affect many consumers.

Although an investigation of the frequency of occurrence of various multipath conditions is beyond the scope of this report, some of the measured data presented in Chapter 6 can be combined with results from a year-2000 FCC field investigation to provide at least a partial answer.

MULTIPATH CAPABILITY BASED ON YEAR-2000 FIELD TESTS

In 2001, the FCC Laboratory reported the results of year-2000 field tests of DTV coverage in Washington, DC and of DTV receiver performance.* In that study, the performance of six DTV receivers was evaluated at 60 locations for reception of two broadcast UHF DTV stations (channels 34 and 48). Nine of the locations were specifically selected for high-multipath conditions; however, 51 locations—referred to as “coverage sites”, were selected in ways that can be expected to yield more representative results. It is these 51 sites that are of interest for the current analysis.

Of the 51 coverage sites, 38 were located at five-mile intervals along radials from the broadcast antenna of digital channel 48 in Washington, DC. The other 13 coverage sites were chosen from sites randomly selected from within a box 17.5 miles on a side, centered on the same broadcast antenna.†

At each site, reception performance measurements were made using at least two antenna systems:

- a log-periodic, outdoor-type antenna on a 30-ft. mast, and
- one of two indoor-type antennas on a 7-ft. tripod located outdoors.

The tripod-mounted antenna measurements were intended to indicate reception performance that could be expected with an antenna located indoors to the extent that could easily be determined given that access to homes or other buildings at randomly selected sites is not generally available. Though the antenna was not located indoors, the height and antenna type were consistent with indoor use. In general, a bow tie antenna was used as the “indoor-type” antenna. If the bow tie failed to achieve reception, a small, indoor, UHF log-periodic antenna (“Silver Sensor”) was tried.

The tests included six DTV receivers, one of which was an instrumented prototype receiver to be used as a reference. Initially, the reference receiver was a second-generation Zenith ProDemodulator. After two thirds of the testing was complete (on July 17, 2000), that receiver was replaced with a third-generation Zenith ProDemodulator. The third generation included an equalizer with longer ghost cancellation times

* Inglis, William H. and Means, David L., “A Study Of ATSC (8-VSB) DTV Coverage In Washington, DC, And Generational Changes In DTV Receiver Performance”, Interim OET Report FCC/OET TRB-00-2, Technical Research Branch, Laboratory Division, Office of Engineering and Technology, Federal Communications Commission, April 9, 2001.

† More specifically, 200 sites were randomly selected within the 17.5-mile box. The tested sites were selected from among these—focusing on sites located in Washington, DC and sites near the FCC Laboratory, in Columbia, MD.

and slightly improved pre-ghost performance at the expense of slightly degraded white noise performance, relative to the second generation.

That same third-generation receiver was tested this year, along with the 28 current-generation consumer receivers, to determine performance against the 47 RF captures, as described in Chapter 6. The result for the third generation reference receiver is shown as the right-most bar (labeled “2000REF”) of Figure 6-1. In the current tests, that receiver—with equalizer technology now two generations behind the latest technology—tied for either the worst or second worst performance (depending on whether counting the zero-error data or the two-error data) when included with the current crop of receivers that were tested. Given that the third generation was used for only one third of the year-2000 tests and that a second generation receiver—with inferior equalizer technology—was used for two thirds of those tests, one can assume that the reported field test results for the “reference receiver” from those earlier tests correspond to receiver with multipath performance at or below the level shown by the “2000REF” bar in Figure 6-1.

In the year-2000 tests, all but one of the 51 sites exhibited field strengths judged to be large enough for theoretical DTV reception.* Using the mast-mounted, outdoor-type antenna, the reference receiver received channel 34 with no visible picture errors in all 50 of those sites and received channel 48 without visible errors in 49 of the 50 sites. Thus, the reference receiver successfully handled multipath conditions in 99 percent of the test-site/broadcast-station combinations with the mast-mounted antenna. When using the tripod-mounted indoor-type antennas (including the Silver Sensor, when needed), the reference receiver handled 85 percent of the test-site/broadcast-station combinations without visible picture errors.

Thus, receivers performing at or below the level of the 2000REF receiver shown in Figure 6-1 were able to successfully handle 99 percent of the multipath situations in the “coverage tests” when using a mast-mounted outdoor antenna. Though the tests involved only one metropolitan area and the sample size was too small to consider these numbers statistically accurate, the sites selected are expected to be far more representative of randomly selected real world conditions than the ATSC-recommended sites, which were chosen because of their difficult multipath conditions. Given that the 2000REF results show performance at or below almost all of the lower-tier performers in the Figure 6-1, one can reasonably assume that, even lower-tier multipath performance (as defined in Chapter 6) is adequate to handle the vast majority of reception conditions (at least in the Washington, DC area) when the receiver is paired with a good outdoor, mast-mounted antenna.

Similarly, receivers performing at or below the level of the 2000REF receiver shown in Figure 6-1 were able to successfully handle 85 percent of the multipath situations in the “coverage tests” when using a indoor-type antenna at a 7-foot height (but located outdoors). It appears likely, then, that multipath performance at the lower tier of Figure 6-1 may be adequate for most locations in conjunction with an indoor antenna, but that improved multipath performance (e.g., the upper tier of Figure 6-1) might offer benefits in many locations.

IMPACT OF REPRESENTATIVE MULTIPATH ON REQUIRED CNR

The year-2000 field tests also offer some insight into the impact of multipath on required CNR for a receiver.

Those tests included measurements of required CNR at each site. The required CNR was determined by adding white Gaussian noise to an amplified version of the signal received from the antenna and adjusting the noise level until the threshold of visibility (TOV) was observed.

* With the mast-mounted antenna, 51 sites were tested. With the tripod-mounted antennas, 50 sites were tested. In both cases, all but one site had sufficient field strength for theoretical DTV reception.

Though the precision of the measurements was limited by the use of one-dB steps in adjusting the noise level, the median required CNR across all of the coverage sites provides an indication of the required CNR in real world multipath conditions. In general it was found that the newer generation receivers performed better—i.e., had a lower required CNR—that older generation receivers. When used with the mast-mounted antenna, the newest generation receiver that was used throughout the test period for the 2001 report (a “third generation” receiver identified as receiver 5 in that report) exhibited a median required CNR of 15.9 dB across all “coverage sites” tested for one of the received broadcast stations and 16.0 dB for the other. With the tripod-mounted antennas, the corresponding numbers were 17.0 and 16.6 dB.

Absent better information, a required CNR of 16.0 dB may be a reasonable estimate of reception performance in typical multipath conditions if an outdoor antenna is used.

CHAPTER 8

SUMMARY AND CONCLUSIONS

The laboratory-based measurements performed for this report emulated two types of over-the-air reception conditions for DTV receivers:

- (1) Unimpaired signal (i.e., no multipath) [Chapters 3 – 5], and
- (2) Signal impaired by multipath (ghosts) [Chapter 6]—focussing on particularly difficult multipath conditions.

The unimpaired signal measurements can be used to quantitatively predict receiver performance under benign reception conditions—i.e., with little multipath. The multipath tests provide a basis for comparing the ability of different DTV receivers to handle difficult multipath conditions—without directly addressing the frequency of occurrence of those multipath conditions.

The linkage developed in Chapter 7 between the new, laboratory-based measurements performed for this report and earlier FCC field-test data provides a basis for anchoring the multipath results to representative, real-world reception conditions.

The purpose of this report has been to provide an empirical basis for answering three questions that derive from study requirements imposed by Congress as part of SHVERA [Chapter 1]. Those questions are as follows.

- (1) Is there is a wide variation in the ability of reasonably-priced consumer digital television sets to receive over-the-air signals, such that at a given signal strength some may be able to display high-quality pictures while others cannot?
- (2) Is such variation related to the price of the television set?
- (3) Should such variation be factored into setting a standard for determining whether a household is unserved by an adequate digital signal?

In addressing these questions, separate answers will be provided for benign signal conditions (little multipath) and difficult multipath conditions. The third question will be addressed by comparing measured results to the receiver performance planning factors in OET-69.

The benign signal case will be evaluated in terms of the measured values of minimum signal at the threshold of visibility of errors (TOV) for the receivers. This specifies the ability of a DTV receiver to operate with a weak signal—absent significant multipath or interference. To provide a better understanding of differences among receivers, the discussion will also delve into two receiver parameters that combine to determine the minimum signal at TOV. These are:

- the white noise threshold (required carrier-to-noise ratio [CNR]); and
- the effective noise figure of the receiver.

The first of these characteristics is a demodulator characteristic that is independent of which TV channel contains the signal of interest. The second is a measure of the internally generated electronic noise of the receiver; it does vary with TV channel. In reporting channel-dependent data, results are presented for the low-VHF, high-VHF, and UHF bands, which were represented in the measurements by TV channels 3, 10, and 30.

VARIATION IN RECEPTION PERFORMANCE

For Benign Signal Conditions

In the low-VHF band, the variation in reception performance among the tested DTV receivers was moderately high. The minimum signal level at TOV exhibited a 3.7-dB standard deviation among the receivers. 89 percent of the receivers exhibited performance within 5.1 dB of the median performance, but two (seven percent) same-brand receivers were significantly worse than the median—by 10.6 and 12.5 dB. Omitting those two receivers from the data set would reduce the standard deviation to 2.3 dB.

In the high-VHF and the UHF bands, the variation in reception performance among the tested receivers was small. In the high-VHF band, the minimum signal level at TOV exhibited a 1.6-dB standard deviation; 89 percent of the receivers exhibited performance within 3.1 dB of the median, and the poorest performing receiver exhibited a performance level 4.3 dB worse than the median. In the UHF band, the minimum signal level at TOV exhibited a 0.9-dB standard deviation; 89 percent of the receivers exhibited performance no worse than 1.3 dB poorer than the median, and the poorest performing receiver exhibited a performance level 2.5 dB worse than the median.

Most of the variation in reception performance among the tested receivers was due to differences in receiver noise figure rather than in required CNR. The noise figure variations were larger than the required-CNR variations by factors ranging from 4.2, in the UHF band, to 16, in the low-VHF band.

For Difficult Multipath Conditions

Independent of band, there was a wide variation in ability of the receivers to handle difficult multipath conditions; however, linkage of the current results with earlier field test results suggest that the observed performance differences are of no consequence in the vast majority of reception locations, if an outdoor, mast-mounted antenna is used. When an indoor antenna is used, the linkage suggests that the observed performance differences would be significant in many, but probably not most, locations.

In tests against RF captures recorded from antennas at sites specifically selected for their challenging multipath conditions, the multipath-handling capability of the receivers fell primarily into two tiers of performance. The upper (better-performing) tier included ten receivers. The lower tier included 16 receivers. Two receivers fell in between the two tiers, but closer to the lower tier. The upper-tier receivers were able to handle about four times as many of the RF captures as the lower tier.

The FCC's year-2000 field tests at 51 sites that were selected without regard to multipath—and thus more likely to be representative of the typical range of common reception conditions than the RF captures—can be used to put the current multipath test results in perspective. A now-obsolete instrumented receiver left over from those earlier field tests was retested this year against the RF captures and was found to perform at the bottom of the lower performance tier. But, in the year 2000 field tests that now-inferior receiver successfully handled multipath in 99% of the combinations of site and broadcast station,^{*} when a mast-mounted outdoor antenna was used. The success rate dropped to 85 percent when an indoor-type antenna was used,[†] indicating an increased likelihood that better multipath performance in the receiver would have helped.

^{*} Out of the 50 sites that had sufficient field strength for theoretical DTV reception.

[†] The indoor antenna was mounted at a 7-foot height, consistent with indoor antenna, but tests were performed outdoors.

PRICE-DEPENDENCE OF RECEPTION PERFORMANCE

For Benign Multipath Conditions

In assessing the price-dependence of receiver performance, one must consider two things:

- (1) whether an observed variation of performance with price among the tested receivers is statistically significant—i.e., whether it represents a real trend among DTV receivers currently on the market or whether it is a statistical artifact of the particular selection of receivers that were tested; and,
- (2) whether an observed variation of performance with price is of sufficient magnitude to significantly affect television performance.

In the low-VHF band, though the variability in performance among the receivers was moderately high, the variability among the price categories was small, and no statistically significant price-dependence of that variation was found. In fact, the median performance of the low-cost TVs was slightly better than that of either the mid-priced or high-priced TVs. The median performance of the tested set-top boxes was poorer than that of the integrated DTVs by 2.3 dB, though it must be noted that these were older designs (2004 and earlier models that were still on the market at the time of this report) than the DTVs.

In the high-VHF and the UHF bands, the variation in reception performance with price was judged to be both small and not statistically significant. The median performance of the high-cost TVs differed from that of the low-cost TVs by less than 0.2 dB. Set top boxes exhibited median performance 0.6 dB and 0.7 dB worse than the median of all TVs in the low-VHF and UHF bands, respectively.

For Difficult Multipath Conditions

The tested receivers fell into two distinct tiers of multipath-handling capability—the upper tier representing a significant performance improvement associated with at least two companies' newest generation of demodulator chips.

Given that both tiers of performance appeared in all three price ranges of DTV receivers, there appears to be no inherent price dependence among the DTVs; however, there was a complete absence of upper-tier performers among the tested set-top boxes. This absence is attributed to the older designs of the set-top box products—all of which were introduced in the year 2004 or earlier. Among the tested receivers, none that were introduced before March 2005 were found to exhibit upper-tier performance, whereas 48 percent of those introduced in or after that month performed at the upper tier level.

RECEPTION PERFORMANCE RELATIVE TO OET-69

For Benign Multipath Conditions

The results show no clear need to adjust planning factors in OET-69 for application to SHVERA. Table 8-1 shows that, for benign multipath conditions, the poorest performing receiver category—*set-top boxes*—exhibited median performance (as indicated by minimum signal at TOV) closely matching predictions based on current OET-69 planning factors, with median performance exceeding the OET-69 predictions by 1.7 dB in high VHF and falling below OET-69 performance levels by less than 1 dB in low VHF and UHF. The median low-cost DTV performance matched OET-69 in the UHF band and was better than OET-69 by about 2 dB in the VHF bands. It should be noted that the tolerance on these measurements is about ± 1 dB.

[It is also noted that, in terms of minimum signal at TOV, the overall median performance of the tested receivers (-82.2, -83.2, and -83.9 dBm, in low VHF, high VHF, and UHF, respectively) matches, within measurement accuracy, the minimum performance standard of -83 dBm recommended by the ATSC.*]

Table 8-1. Net Performance for Unimpaired Signal Relative to OET-69 Model

| Band | Median of All Test Samples | Median Low-Cost DTV | Median Set-Top Box |
|------------------|----------------------------|---------------------|--------------------|
| Low VHF (Ch.3) | 1.2 dB better | 2.3 dB better | 0.7 dB worse |
| High VHF (Ch.10) | 2.2 dB better | 2.4 dB better | 1.7 dB better |
| UHF (Ch.30) | 0.1 dB worse | 0.1 dB better | 0.8 dB worse |

A breakdown of the results by individual planning factors is shown in Table 8-2. Median required carrier-to-noise ratios (CNRs) closely match the OET-69 value, as does the system noise figure in UHF. The median VHF noise figures of the tested receivers were better than the OET-69 values, with the exception of the set-top box median in low VHF, which was only 0.5 dB above (worse than) the OET-69 value.

Table 8-2. Planning Factor Measurements with Unimpaired Signal

| Planning Factor | OET-69 | Overall Median of Test Samples | Median Low-Cost DTV | Median Set-Top Box |
|--------------------------------------|-------------------|--------------------------------|---------------------|--------------------|
| Required Carrier-to-Noise Ratio (dB) | 15.2 [†] | 15.3 | 15.3 | 15.4 |
| System Noise Figure (dB) in Low VHF | 10.0 | 8.8 | 7.4 | 10.5 |
| System Noise Figure (dB) in High VHF | 10.0 | 7.6 | 7.5 | 7.8 |
| System Noise Figure (dB) in UHF | 7.0 | 6.9 | 6.9 | 7.5 |

Note: for all parameters, lower values correspond to better performance

Adjustment for Multipath

The required CNRs presented above were measured for an unimpaired signal. In the presence of significant multipath, it is known that higher CNRs are required. We have performed no measurements of this effect on the current generation of receivers; however, field tests from the year 2000 yielded a value of 16 dB for the median required CNR across 50 test sites using the then newest generation of DTV receiver hardware and an outdoor, mast-mounted antenna. This is only 0.7 dB above the median measured value from the receiver tests using a benign signal. If the net performance data of Table 8-1 were degraded by 0.7 dB to reflect this value for required CNR, it can be seen that the results would still closely match OET-69 predictions.

Overall Conclusion Regarding Adjustment to Planning Factors

While adjustments to the OET-69 planning factors could be made based on the test results presented in this report in combination with results from the year-2000 field tests, the overall effect on performance predictions would be small. Combining the 16-dB required CNR value, as discussed above, with the overall median noise figures would yield more optimistic predictions than the current OET-69 by 0.4 dB

* "ATSC Recommended Practice: Receiver Performance Guidelines", ATSC Doc. A/74, Advanced Television Systems Committee, 17 June 2004, p.11.

[†] See note for Table 1-1.

and 1.6 dB, respectively, in the low-VHF and high VHF bands, and less optimistic predictions by 0.7 dB in the UHF band. Given the tolerances on the measurements, such adjustments to the existing methodology are not recommended.

APPENDIX A

TEST CONFIGURATIONS, ISSUES, AND PROCEDURES

TEST CONFIGURATIONS

This appendix provides additional information regarding test configurations, procedures, and issues that arose during the testing.

General Information on the Test Configurations

All test and measurement setups maintained a 50-ohm impedance throughout, except at the signal source and the consumer TV inputs, which were each specified to be nominally 75 ohms. (An older, instrumented reference receiver identified as 2000REF in this report had a 50 ohm input impedance.) The 75-ohm devices were matched to the rest of the test setup through minimum-loss impedance-matching pads, except that, in the test setup that employed a splitter, an impedance-matching transformer was used at the signal source to reduce losses.

Attenuation pads were used throughout each test configuration to reduce the effects of any impedance mismatches at places where such mismatches were considered likely or would be expected to have a significant impact. A 50-to-75-ohm impedance-matching pad used at the input of each consumer DTV receiver served both as an impedance-matching device and as a 5.8-dB attenuator to attenuate reflections due to deviations of the TV antenna inputs from the nominal 75-ohm value.*

Splitter Test Configuration

Figure A-1 shows a block diagram of the “splitter test configuration”, which was used for tests of white noise threshold and multipath performance.

An RF player (Sencore RFP-910) playing the “Hawaii_ReferenceA” file supplied with the player was used as the ATSC 8-VSB signal source, for reasons discussed in the “Test Issues” section of this appendix. Amplifiers for the signal operated at RMS levels that were more than 17-dB below the specified 1-dB compression points in order to ensure linearity.

For the white noise tests, noise was supplied by a noise generator, which was then externally filtered to roll off the noise beyond 700 MHz—well above the tested frequencies.

Both signal and noise levels were adjusted using step attenuators that could provide 0 to 81 dB of attenuation in 0.1-dB steps.

Signal and noise were combined using a directional coupler, then divided nine ways by means of two cascaded layers of three-way splitters, each specified to have a minimum isolation of 14 dB between inputs. The splitters were followed by 25-foot long, well-shielded, low-loss cables, each of which drove either an impedance-matching pad (nominally 5.8-dB power attenuation) for connection to a consumer TV receiver or a 50-ohm attenuator pad (nominally 6-dB attenuation) for connection to measuring instruments or to the instrumented receiver. The nine outputs—at the output of the final pads—are designated by port numbers Pt1, ... Pt9 when the final pad is an impedance-matching pad, as when driving a consumer DTV. An “a” is suffixed onto the port numbers when the final pad is a 50-ohm pad, as when driving a measurement instrument (vector signal analyzer or spectrum analyzer) or an

* The intent was both to minimize standing waves on the 25-foot, low-loss cables and to reduce the impact of RF energy reflected back from a poorly matched TV on signals delivered to other TVs through the splitter.

instrumented receiver having a 50-ohm input impedance. Port Pt5a was always used as the measurement port.

The splitter arrangement allowed the signal and noise to be simultaneously delivered to as many as eight TVs and to a vector signal analyzer used for measurements. Any amplitude mismatch between the various ports, though small, was not of concern because the signal levels for multipath testing were not critical and because white noise threshold tests involve the ratio of two measurements (signal and noise) that were made on the same port and using the same amplitude range of the spectrum analyzer to eliminate the effect of small errors in absolute measured levels.

Minimum Signal Test Configuration

Figure A-2 is a block diagram of the configuration used for measuring minimum signal at TOV.

An RF player (Sencore RFP-910) playing the “Hawaii_ReferenceA” file supplied with the player was used as the ATSC 8-VSB signal source, for reasons discussed in the “Test Issues” section of this appendix.

Because minimum input signal at TOV is an absolute measurement rather than a ratio, a signal splitter was not used for these tests. The 25-foot low-loss coaxial cable carrying the signal was connected through a 10 dB attenuator and an impedance matching pad (50 to 75 ohms, 5.8 dB power attenuation) to the TV input. After signal level was adjusted to achieve TOV on the TV, the cable and 10-dB pad—but not the impedance matching pad—were moved to the vector signal analyzer input for the signal level measurement, which then had to be corrected for measured loss of the impedance matching pad.

CALIBRATION AND SIGNAL QUALITY TESTS ON TEST SETUPS

Impedance-Matching Devices

The power loss of 14 identical minimum-loss impedance-matching pads (Trilithic model ZM-57) and two impedance-matching transformers (Trilithic ZMT-57) were measured as a function of frequency. The devices were labeled with individual numbers for identification; designations were MLP#1 through MLP#14 for the minimum-loss impedance-matching pads and TT#1 and TT#2 for the transformers.

The losses of the individual impedance matching devices were determined from loss measurements performed on back-to-back pairs of impedance-matching devices. These measurements were performed by measuring signal levels versus frequency for a tracking generator signal and for that signal as attenuated by a back-to-back pair of impedance-matching devices (50 ohms to 75 ohms to 50 ohms) to determine the loss versus frequency for each tested pair of devices. (Loss was computed by subtracting the measured output level versus frequency of the tested devices from the output level versus frequency of the tracking generator, measured with the same spectrum analyzer settings [including input attenuation and reference level] in order to ensure that loss measurements were accurate.) The measured combinations included MLP#13 with each of the other devices and MLP#14 with each of the other devices. The difference between losses of MLP#13 and MLP#14 was computed as the difference between average loss of the combinations of MLP#13 with MLP#1 through MLP#12 and average loss of the combinations of MLP#14 with MLP#1 through MLP#12. The loss of MLP#13 combined with MLP#14 determined the sum of losses of MLP#13 and MLP#14. Combining this information allowed computation of the individual losses of MLP#13 and MLP#14. The loss of each of the other devices could then be computed by subtracting the loss of MLP#13 from the measured loss of the combination of that device with MLP#13, or by performing a similar calculation based on MLP#14; in fact, both computations were performed and the results averaged to determine the loss of those devices.

The unit-to-unit variation of the loss of the impedance matching pads at channel-30 frequencies was of interest because of their use in the splitter test setup. The pads were found to be quite well matched—with samples ranging from 5.79 to 5.84 dB at the frequency of TV channel 30.

All of the pads and both transformers were found to be flat to within 0.02 dB across the 6-MHz bandwidths of each tested channel (3, 10, and 30).

TV-channel-specific measurements of absolute loss of one impedance matching pad (MLP#12) were used in determining minimum signal at TOV because the actual signal level measurement did not include the loss of that pad. Those losses were 5.70, 5.73, and 5.82 dB, respectively, on channels 3, 10, and 30.

The frequency-dependent measurements of the loss of one impedance-matching transformer (TT#1) were used in determining the frequency response of the splitter test configuration to the 50-ohm outputs (Pt5a and Pt8a).

Splitter Test Configuration

Because of the complexity of the splitter test configuration, which included amplifiers, a noise generator, a directional coupler, and splitters that were not a part of the simpler minimum-signal test configuration, additional tests were performed to verify its performance. The tests evaluated the frequency response (including the potential effect of errors in input impedance of the TVs), port-to-port matching, signal and noise spectral characteristics, and signal quality.

Frequency Response and Effect of Mismatched Loads

The splitter test configuration (Figure A-1) provided nine identical output ports, each of which could be configured for connection to a 75-ohm device (the antenna port of a consumer DTV) or to a 50-ohm device (vector signal analyzer, spectrum analyzer, or an instrumented reference receiver having 50 ohms input impedance). Configuration of each port was performed by connection of either an impedance-matching pad (50 to 75 ohms, 5.8 dB nominal power attenuation) or a 50-ohm pad (6 dB \pm 0.5 dB) at the final output of the port (end of the 25-foot low loss cable). The ports were designated Pt1, ... Pt9 when matched to 75 ohms. A suffix “a” was added to the designation of ports matched to 50 ohms. Only two ports were ever configured for 50 ohms during the reported tests: the fifth port (Pt 5a), which always served as the measurement port; and the eight port (designated Pt8a, when so configured), which was used to connect to the instrumented, 50-ohm input receiver designated 2000REF for one set of tests.

Figure A-3 shows the frequency response of the entire test setup from the output of the ATSC signal source (PtA in Figure A-1) to each of the final output ports. For port 8, separate results are shown for the Pt8 and Pt8a configurations. During the measurements, all ports except that being measured were terminated in the appropriate impedance—either 50 or 75 ohms. The response of each port was flat to well within 0.1 dB (maximum – minimum) across the 6-MHz bandwidth of TV channel 30. The gain of each 75-ohm port matched that of the measurement port (Pt5a) within 0.2 dB.

A test was also performed to determine whether frequency response on one port would be significantly affected by impedance mismatches on other ports, since consumer TVs may not have carefully controlled input impedance. Figure A-4 shows three frequency response plots measured on Port Pt5a under three different load conditions for the other eight ports: ideal terminations (75 ohms), actual TVs (tuned to channel 30), and open circuits. With TV’s as loads the frequency response across channel 30 remained flat to well within 0.1 dB. With open circuits on all eight ports, flatness degraded somewhat, but was still well within 0.2 dB across channel 30.

All of the above tests were performed by using a spectrum analyzer and tracking generator, as shown in Figure A-5. In all cases the tracking generator signal (connected through an attenuator pad to stabilize the

impedance) was injected at PtB in Figure A-1 so that a 50-ohm source could be used. For frequency response tests of 75-ohm ports, the losses in TT#1, the impedance-matching transformer that normally connected the 75-ohm ATSC source to PtB, were included by using TT#1 to match the impedance of the selected port to the 50-ohm input of the spectrum analyzer. For frequency response tests of 50-ohm ports, TT#1 was omitted from the measurement, but its losses as a function of frequency (measured separately) were included in the computed frequency response. In all cases, the tracking generator signal—as attenuated by the 10-dB pad shown in Figure A-5—was measured by the spectrum analyzer as a reference in the frequency response calculations. All measurements were performed with the same spectrum analyzer settings (including input attenuation and reference level) in order to ensure accuracy of the computed frequency response function.)

Signal Spectrum, Noise Spectrum, and Signal Quality

Spectrum and modulation error ratio measurements indicate that a high quality test signal and spectrally flat noise were delivered to the output ports of the test setup.

Figure A-6 shows spectra of the injected signal and noise as measured at Pt5a during playback of the “Hawaii_ReferenceA” file from the RF capture player at a CNR of 15 dB. The spectra were measured with a 30-kHz resolution bandwidth, 300-kHz video bandwidth, RMS detection, and trace-averaging (in linear power units) of 8192 traces. (This averaging was performed across multiple loops of the test signal). The noise spectrum is flat across the 6-MHz bandwidth of TV channel 30 to within 0.34 dB (maximum – minimum) for the spectrum as shown and to within 0.11 dB when a 500-kHz smoothing width is applied to average out some of the randomness of the measurement. Similarly, the signal spectrum is flat across the 4.76-MHz wide “head” (i.e., flat part) of the ATSC signal to within 0.59 dB for the spectrum as shown and 0.38 dB when 500-kHz smoothing is applied.

Modulation error ratio (MER) measured by the vector signal analyzer during the tests of required CNR was a respectable 33 to 35 dB without including any equalization in the vector analyzer and 37 dB with equalization.

Other Checks

A test was performed to ensure that any impedance mismatch at PtC in Figure A-1 would not affect the level of injected noise from the noise generator through the resulting variations in impedance at the signal input to the directional coupler as the signal step attenuator was varied. The noise level step attenuator was adjusted to achieve -70 dBm noise level at Pt5a. Amplifier A2 was then replaced by a short circuit at PtC and the noise level at Pt5a was measured for two different settings of the signal attenuator—0 dB and 81 dB. The measured variation in noise power was only 0.01 dB.

To ensure that amplifier A2 (Figure A-1) was not operated in a non-linear region that might affect signal quality, the signal level at the output of A2 was measured during playback of the “Hawaii_ReferenceA” file. The measured level was 17.5 dB below the 1-dB compression point of the amplifier.

Signal-to-noise ratio of the signal path (excluding any noise generated by the RF player) was measured to ensure that amplifier noise (from A1 and A2 in Figure A-1) did not significantly affect results. SNR in a 6-MHz bandwidth was found to be 64 dB on channel 30.

TEST ISSUES

A few observations regarding issues that arose during the test program may be of value to others who perform DTV receiver performance testing.

Multipath Performance Testing Using the RF Player

After we had tested 16 DTV receivers against each of the 47 RF captures, visiting engineers from a DTV chipset developer (ATI Research) observed video errors on one of the TVs during playback of a few captures. Though all tested TVs were able to play some of the captures with no visible errors, the visiting engineers suggested that the errors observed on some specific captures indicated that the FCC's RF player was not functioning properly. This conclusion was based on two factors: (1) they had tested a TV with the same technology at their labs and found it had produced no visible errors on those specific captures; (2) they reported having had problems with several of their own RF capture players that produced visible errors which went away after calibration and repair of the player.

Based on these observations, we sent our RF player back to the manufacturer for repair and calibration; the manufacturer indicated that our problem had been caused by a ground plane error on one of the cards. After they replaced that card and recalibrated the unit, the difference was dramatic. A TV that had successfully handled only 10 of the captures with no visible errors before the repair was able to handle 31 of the captures without visible errors after the repair. We subsequently discarded all previous results and repeated all testing.

As an additional confirmation of performance of our RF player—in conjunction with our entire splitter-based test setup, ATI allowed us to test two DTV samples (subsequently identified as “upper tier” performers in Chapter 6) at their laboratories using their equipment. The net test results (number of captures played with no visible errors and number played with no more than two visible errors) at the FCC using our test setup with our repaired RF player matched those that we performed at ATI for one of the TVs. For the other TV, the tests at the FCC showed three more captures producing two or fewer errors (including zero errors), but showed two fewer captures producing no errors. Given the variability in results that sometimes occur between playback loops along with the subjective judgment in identifying visual errors, these differences were considered acceptable.

RF Source for Measurements of White Noise Threshold and of Minimum Signal

Our plan had been to use the RF player as an ATSC source only when performing multipath testing. An ATSC signal generator was to be used for testing of white noise threshold and of minimum signal at TOV.

In initial tests of 16 DTV receivers using the signal generator as a source, the white noise threshold of the best tested receiver was found to be 15.25 dB. This was slightly higher than the 14.9 to 15.0 dB that had been expected for the better-performing receivers; consequently, the generator was sent back to its manufacturer for calibration and checkout. Upon its return, retesting of that best performing receiver yielded a white noise threshold 16.0 dB—indicating degraded signal quality.

After the poor result with the signal generator, white noise threshold was measured again, but this time using the RF player and a laboratory-recorded DTV signal file designated “Hawaii_ReferenceA” as the signal source. The measured white noise threshold of that same receiver was then found to be 14.94 dB. Based on these results, the ATSC signal generator was replaced by the RF player, which was then used for all testing reported herein. (Previous test results were discarded and all tests were repeated.)

Getting DTV Receivers to Recognize a DTV Signal

The channel-selection “intelligence” of many DTVs combined with certain artificialities of laboratory-based testing to create some challenges.

With analog television, to receive a signal on a given TV channel you simply select that channel. With DTV, there is another layer involved channel selection. To simplify the DTV transition for the consumer, a DTV signal includes coding that tells the TV the channel number of the analog station that is associated

with that DTV signal. In Washington, DC, for example, the DTV broadcast on channel 48 includes information linking it to an analog broadcast on channel 4. A TV viewer not aware of the digital broadcast on channel 48 can tune to a channel he or she may already view—channel 4—and the digital television will automatically set its tuner to channel 48 to select the digital broadcast containing the same programming as the viewer would have seen on analog channel 4.

To facilitate this extra layer in channel selection, DTVs include a channel scan function that is used on initial setup of the TV. The function causes the tuner to sequence through all TV channels searching for analog and digital signals. It creates a mapping from the analog channel numbers to the digital ones and may also identify available sub-channels on each DTV broadcast, since the DTV transmission system enables transmission of more than one program within a single RF TV channel. Many of the TVs will not allow a DTV signal to be received unless it has been identified by such a scan.

The laboratory tests described in this report created two types of anomalies—one associated with the tests of minimum signal at TOV and the other associated with multipath testing using the RF captures.

The minimum signal tests were performed on channels 3, 10, and 30. The available equipment allowed creation of the signal on only one channel at a time; consequently, any channel scan identified only one channel, and when the channel was changed for the next set of tests, the channel scan had to be repeated.

For the multipath testing, a less obvious problem occurred. All testing was performed on channel 30, so one might expect that a single channel scan on each TV would enable testing with all 47 captures. While this worked for some TVs, it did not for others. The original source material for the captures was recorded from eight DTV channels in two cities. Many of the receivers were “confused” by changing broadcast stations (from one capture to the next), even though the RF channel remained constant. Many would not allow selection of the signal as channel 30; instead, the signal had to be tuned indirectly by selecting the channel number of the analog broadcast associated with the recorded digital broadcast—which could only occur after a channel scan.

Thus, each time that an RF capture was loaded, if it originated from a different broadcast station from the last, steps had to be taken to ensure that each TV recognized the new signal. The necessary steps varied among the TVs. Some immediately displayed the new video. For others, simply pressing the channel up or down button caused the signal to be selected. For TVs requiring a new channel scan, some allowed the user to select a single channel number to rescan (channel 30 in this case), while other required a more time consuming rescan of all channels. For some TVs, even a complete rescan was not sufficient to lock in the new signal; unplugging the TV from its power source followed by a channel rescan was usually sufficient in those cases.

To save time in the multipath testing process, the captures were sorted by originating broadcast station before testing. This reduced the number of transitions between broadcast sources so that fewer channel scans would be necessary. To further assist in testing, the captures were sorted—within each originating channel group—to allow the more benign captures from a given broadcast station to be played first in order to lock the receivers onto each new broadcast station using a signal for which success would be likely. It was found, however, that during subsequent testing with captures exhibiting more challenging multipath conditions, some TVs would change channels—or even turn off—during the period when no recognizable signal was received. Consequently, it was often necessary to return to an easier capture from the same broadcast source at various times during the testing to ensure that the TVs were still locked on to that broadcast.

PROCEDURES

Test procedures applicable to the DTV measurements conducted for this report are shown below.

General

The following procedures apply to all measurements.

- Warmup
 - ◇ Allow all test equipment (signal and noise sources, amplifiers, measurement equipment) to warm up for a minimum of 2 hours before testing.
 - ◇ Allow all TVs to warm up at least one hour before testing
- Test equipment calibration
 - ◇ Before each measurement sequence using the spectrum analyzer, perform a full alignment—including RF alignment requiring an external cable connection to the built in calibrated source. (Spectrum analyzer is used only for measurements of test configuration parameters such as frequency response and output spectrum.)
 - ◇ Before each measurement sequence using the vector signal analyzer, invoke the “single cal” function to calibrate the instrument.
- Measurement of applied signal and noise levels
 - ◇ Use averaging times of approximately 21 seconds (1200 averages on vector signal analyzer) when measuring signal levels and ensure that the averaging interval begins just after the start of a playback loop on the RF player and ends before completion of that loop in order to avoid averaging across the loop restart.
 - ◇ For measurements of noise levels, use averaging times ≥ 21 seconds.
- Identifying visual errors in video
 - ◇ Allow the RF player to play the selected signal through at least three complete loops before making observations.
 - ◇ Do not count errors occurring at each loop restart of the RF player
 - ◇ Do not count errors associated with known recording defects due to dropped symbols (Appendix B)
 - ◇ Horizontal streaks occupying a single scan line are judged to be defects in video source material prior to conversion to MPEG format for broadcast and are not counted.
 - ◇ For an error burst lasting longer than one second, count the number of errors as the approximate duration of the burst in seconds.

White Noise Threshold Tests

Note that all measurements are performed using the vector signal analyzer (VSA), and all attenuator settings and measurements are entered into a spreadsheet that performs the required computations.

- Connect equipment as shown in Figure A-1
- VSA setup
 - ◇ Run DTV measurement software*
 - ◇ Set number of averages to 2000
 - ◇ Set broadcast channel 30
 - ◇ Execute “single cal”
 - ◇ Set amplitude range to -50 dBm (most sensitive range)
- RF player setup
 - ◇ Load “Hawaii_ReferenceA” file
 - ◇ Set output channel to 30
 - ◇ Set output level to -30 dBm
- Noise generator setup
 - ◇ Set the internal noise attenuator to 0 dB

* "Control Software for the HP89400 Vector Signal Analyzer for Measuring DTV and NTSC Signals", VSA5.BAS, Version 5.02, Gary Sgrignoli

- Measure VSA self noise by connecting a 50-ohm termination to the VSA input and performing a “long average power” measurement. (This value will be subtracted—in linear power units—from all subsequent measurements.).
- Connect the VSA to Pt5a (Figure A-1)
- Measure modulation error ratio (MER) as an indication of signal quality
 - ◊ Set noise attenuator to 81 dB
 - ◊ Set signal attenuator to point at which VSA indicates occasional clipping (typically 24 dB attenuation) in order to maximize signal to VSA-noise ratio
 - ◊ Measure MER four times and average the results. The measurements are performed without any equalization in the VSA.
- Set and measure injected noise level
 - ◊ Set signal attenuator to 81 dB
 - ◊ Adjust noise attenuator to the 0.1-dB step that most closely yields a “long average power” reading of -70 dBm
 - ◊ Measure the “long average power” twice. (Actual injected noise power will be computed by averaging these two measurements with two similar measurements performed after the TV tests and subtracting—in linear power units—the VSA self noise. Though the correction for VSA self noise is performed in the spreadsheet, the correction is essentially negligible because VSA self noise is about 27 dB below the injected noise level.)
- Set signal to a high level and take whatever steps are necessary to ensure that all connected TVs are tuned to the signal and producing a picture.
- TV tests. Repeat for each of the connected TVs (typically eight). Include receiver D3 in each test sequence as a consistency check.
 - ◊ Adjust signal level upward as necessary to obtain a picture
 - ◊ Adjust signal level downward until picture either drops out or exhibits a high visual error rate
 - ◊ Adjust signal level upward in 0.1-steps to achieve the lowest signal level that produces a picture that is free of visual errors for 10 seconds. Record this attenuator setting.
 - ◊ Adjust signal level upward in 0.1-steps as needed to achieve the lowest signal level that produces a picture that is free of visual errors for 60 seconds. Record this attenuator setting.
 - As a consistency check, the spreadsheet computes difference between attenuator setting in previous step and current attenuator setting. This difference is typically between 0 and 0.2 dB.
 - ◊ Perform “long average power” measurement as described below. This measurement represents the total of the injected signal level, the injected noise level (typically about 15 dB below the injected signal level), and the VSA self noise (typically about 42 dB below the injected signal level).
 - The measurement should be initiated near the end of a playback loop, so that—following the initial operations performed when “long average power” is selected—the actual long integration will begin just after the start of the RF playback loop. The reading of average power should be taken just before the end of that playback loop.
 - As a consistency check, the spreadsheet calculates the sum of the signal attenuator setting and the measured power level. This sum should be nearly constant across all TV measurements.
 - Spreadsheet calculates injected signal level by subtracting—in linear power units—the injected noise level and the VSA self noise from the measured power. The injected noise level subtraction typically results in a correction slightly larger than 0.1 dB. The VSA self noise correction is negligible.
 - Injected signal-to-noise ratio (SNR), termed the carrier-to-noise ratio (CNR) in this report, is computed. (A subsequent adjustment is made for TV self-noise—based on measurements of minimum signal at TOV; however, this correction is essentially negligible.)
 - ◊ Confirm that the measured level is sufficient for relocking on to the DTV signal.
 - Reduce signal level by 20 dB for 20 seconds. Return to previous level and verify that the TV recaptures the signal.

- ◇ Repeat steps for other TVs
- Measure injected noise level
 - ◇ Set signal attenuator to 81 dB
 - ◇ Measure the “long average power” twice for use as described following 1st measurements of injected noise level.

Because both the injected noise power measurement and the injected signal measurement were performed using the same vector signal analyzer on the same amplitude range, the CNR is expected to be quite accurate, since it doesn't depend on the absolute calibration accuracy of the measuring instrument.

Additional information on the testing is included in the “Measurement Method” section of Chapter 3.

Minimum Signal Tests

Note that all measurements are performed using the vector signal analyzer (VSA), and all attenuator settings and measurements are entered into a spreadsheet that performs the required computations. The tests are performed for TV channels 3, 10, and 30.

- Connect equipment as shown in Figure A-2.
- VSA setup
 - ◇ Run DTV measurement software*
 - ◇ Set number of averages to 1200
 - ◇ Set selected broadcast channel
 - ◇ Execute “single cal”
 - ◇ Set amplitude range to -50 dBm (most sensitive range)
- RF player setup
 - ◇ Load “Hawaii_ReferenceA” file
 - ◇ Set output channel to selected channel
 - ◇ Set output level to -30 dBm
- Measure VSA self noise three times by connecting a 50-ohm termination to the VSA input and performing a “long average power” measurements. (The average of these measurements will be subtracted—in linear power units—from all subsequent measurements.)
- TV tests. Repeat for each of TV to be tested (typically eight). Include receiver D3 in each test sequence as a consistency check.
 - ◇ Connect output of the test setup through impedance-matching pad MLP#12, as shown by the solid lines on the right side of Figure A-2.
 - ◇ Set signal to a high level and take whatever steps are necessary to ensure that TV is tuned to the signal and producing a picture.
 - ◇ Adjust signal level downward until picture either drops out or exhibits a high visual error rate
 - ◇ Adjust signal level upward in 0.1-steps to achieve the lowest signal level that produces a picture that is free of visual errors for 10 seconds. Record this attenuator setting.
 - ◇ Adjust signal level upward in 0.1-steps as needed to achieve the lowest signal level that produces a picture that is free of visual errors for 60 seconds. Record this attenuator setting.
 - As a consistency check, the spreadsheet computes difference between attenuator setting in previous step and current attenuator setting. This difference is typically between 0 and 0.2 dB.
 - ◇ Perform “long average power” measurement as described below.
 - The measurement should be initiated near the end of a playback loop, so that—following initial operations performed when “long average power” is selected—the actual long

* "Control Software for the HP89400 Vector Signal Analyzer for Measuring DTV and NTSC Signals", VSA5.BAS, Version 5.02, Gary Sgrignoli

- integration will begin just after the start of the RF playback loop. Confirm that the integration ends before completion of the playback loop.
- As a consistency check, the spreadsheet calculates the sum of the signal attenuator setting and the measured power level. This sum should be nearly constant across all TV measurements.
 - Spreadsheet calculates injected signal level by subtracting—in linear power units—the VSA self noise from the measured power (a correction that is typically less than 0.1 dB) and then subtracting (in dB) the power loss of impedance-matching pad MLP#12 for the specific TV channel tested.
- ◇ Repeat steps for other TVs

Additional information on the testing is included in the “Measurement Method” section of Chapter 4.

Multipath Tests (RF Captures)

Note that in-band injected signal power (6-MHz bandwidth centered at channel 30) was measured at Pt5a (Figure A-1) using the vector signal analyzer (VSA) for each of the 47 RF captures during tests of the first group of eight receivers. These measurements were not repeated for subsequent receivers because small variations in absolute signal level applied to the receivers were not expected to affect the results.

- Connect equipment as shown in Figure A-1
- VSA setup
 - ◇ Run DTV measurement software*
 - ◇ Set number of averages to 2000
 - ◇ Set broadcast channel 30
 - ◇ Execute “single cal”
 - ◇ Set amplitude range to -20 dBm
- RF player setup
 - ◇ Set output channel to 30
 - ◇ Set output level to -30 dBm
- Signal and noise attenuators
 - ◇ Set signal attenuator to 0 dB. This was found to provide a median in-band signal power of -29.7 dBm across the 47 RF captures. This is 53 dB above the minimum signal level at TOV for typical receivers; consequently, any variations in absolute level among the captures was not expected to affect the test results.
 - ◇ Set the noise attenuator to 81 dB to effectively eliminate injected noise.
- Measure modulation error ratio (MER) as an indication of signal quality.
 - ◇ Load “Hawaii_ReferenceA” file
 - ◇ In the first series of tests, MER was measured twice with internal equalizer off. The average of the measurements was 35.5 dB.
- Tests for a given capture

(Note that captures are loaded and tested sequentially in groups for which the originating TV broadcast channel is the same. Within each group, captures that are deemed to be easier to acquire—due to benign multipath conditions—are loaded first to increase the likelihood of a successful channel scan on each TV.)

 - ◇ Load the selected RF capture
 - ◇ Ensure signal acquisition for all TVs, to the extent possible
 - If this capture corresponds to a different broadcast TV channel than the last capture, take whatever steps are necessary to ensure that all connected TVs are tuned to the signal and have an opportunity to produce a picture. This may include channel scans or disconnecting power.

* "Control Software for the HP89400 Vector Signal Analyzer for Measuring DTV and NTSC Signals", VSA5.BAS, Version 5.02, Gary Sgrignoli

To improve probability of success, the first capture loaded should have as benign multipath conditions as possible.

- If this capture corresponds to the same broadcast TV channel as the last, then check to see that all TVs have acquired the signal (i.e., are producing a TV picture). If not, try channel scans or returning to a more benign capture from the same broadcast channel to achieve acquisition.
- ◇ Wait for at least three full playback loops to be completed before judging TV receiver performance.
- ◇ TV tests. Repeat for each of the connected TVs (typically eight). Include receiver D3 in each test sequence as a consistency check.
 - Observe video on the selected TV and count the number of video errors observed during a single playback loop. If performance is monitored over several loops and, if the results vary, select the median number of errors as the value to record. A video error burst lasting more than one second is counted based on the approximate duration in seconds. Thus, an error burst lasting three seconds is counted as three errors. Errors occurring during or immediately after the loop-restart time are not counted, nor are errors associated with known defects (dropped symbols) in eight of the captures, as documented by the ATSC.*
 - Repeat for next TV
- ◇ Repeat for next RF capture

Additional information on the testing is included in the “Measurement Method” section of Chapter 4.

EQUIPMENT

Table A-1 identifies the equipment used for the tests that were conducted for this report.

Table A-1. Equipment List

| MAKE | MODEL | EQUIPMENT | S/N | CAL DATE | USE |
|-----------|----------|------------------------|---------------------------|----------|--|
| Sencore | RFP910 | RF Player | 007, Run 11A | 8/10/05 | ATSC source for all tests |
| Agilent | 89441A | Vector Signal Analyzer | US40514809 /US39313048 | 9/17/04 | CNR measurements before 8/30/05; amplitude of injected captures before 8/30/05 |
| Agilent | 89441A | Vector Signal Analyzer | US40514815 /US39313021 | 8/8/05 | CNR measurements after 8/30/05; All minimum signal measurements |
| Agilent | E7405A | Spectrum Analyzer | US41160406 | 10/27/04 | Calibration of minimum-loss impedance-matching pads (6/7/05) |
| Agilent | E7405A | Spectrum Analyzer | US41160425 | 8/16/05 | Frequency response of splitter test configuration |
| Noise/Com | UFX-7110 | Noise Generator | P292-0135 | ** | Noise source for white-noise threshold tests |

Notes:

** Last factory calibration was 8/21/01, but for the reported tests, output was calibrated by means of Agilent E7405A spectrum analyzer at the time of each test.

* See Table B-1 in Appendix B of this report, or the “Quality of Capture” column of the continuation of Figure A-1 on p.28 of “ATSC Recommended Practice: Receiver Performance Guidelines”, ATSC Doc. A/74, Advanced Television Systems Committee, 17 June 2004.

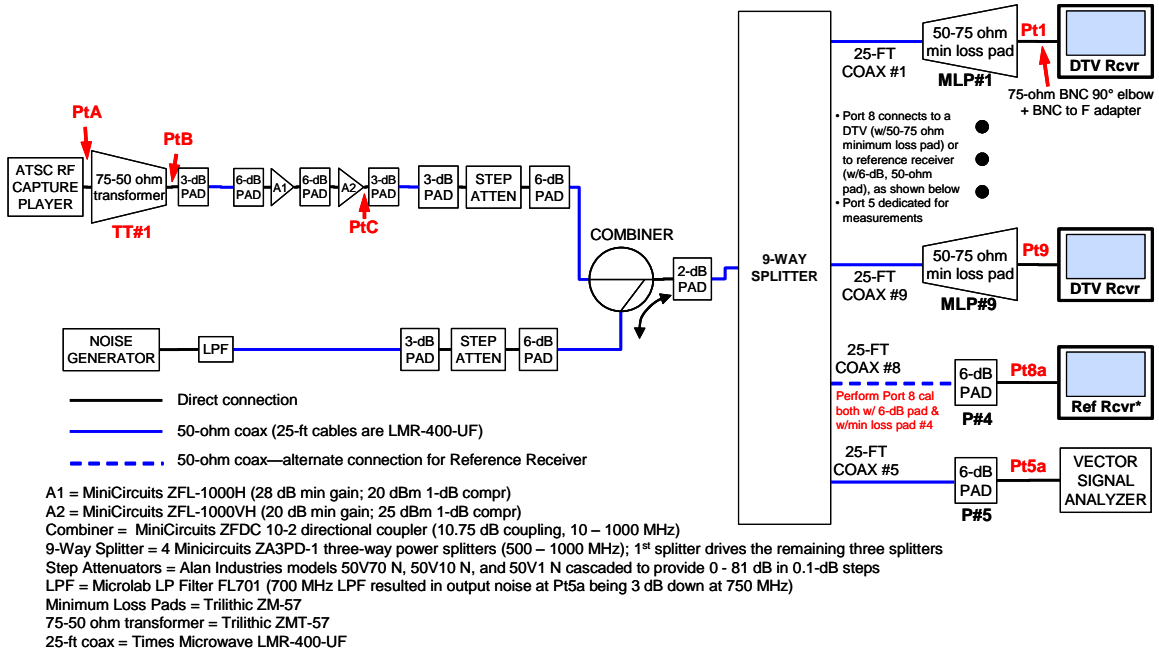

Figure A-1. Block Diagram of Test Configuration for Required CNR and RF Capture Tests

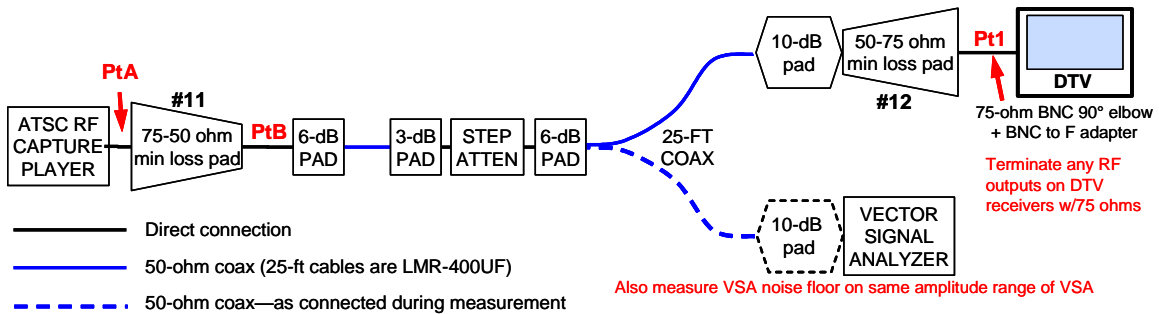

Figure A-2. Block Diagram of Test Configuration for Minimum Signal at TOV

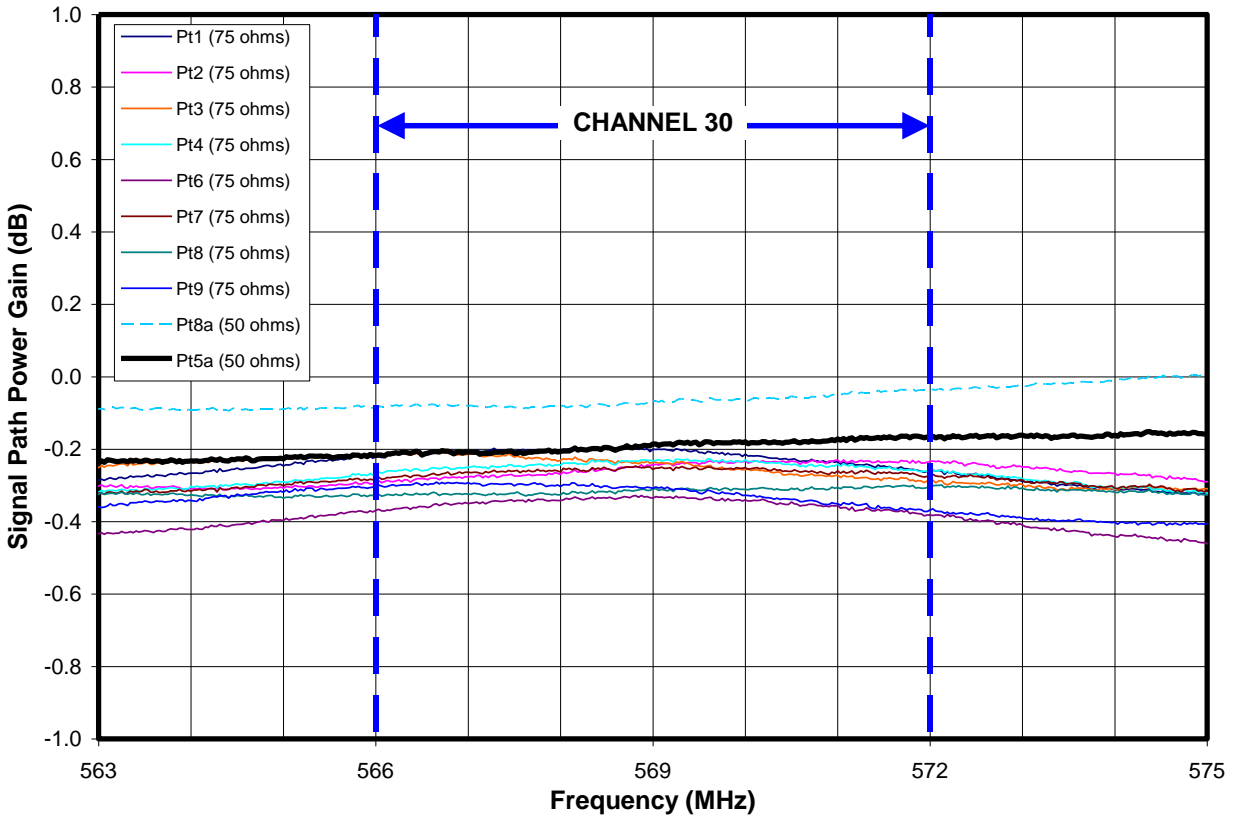

Figure A-3. Frequency Response of Each Port

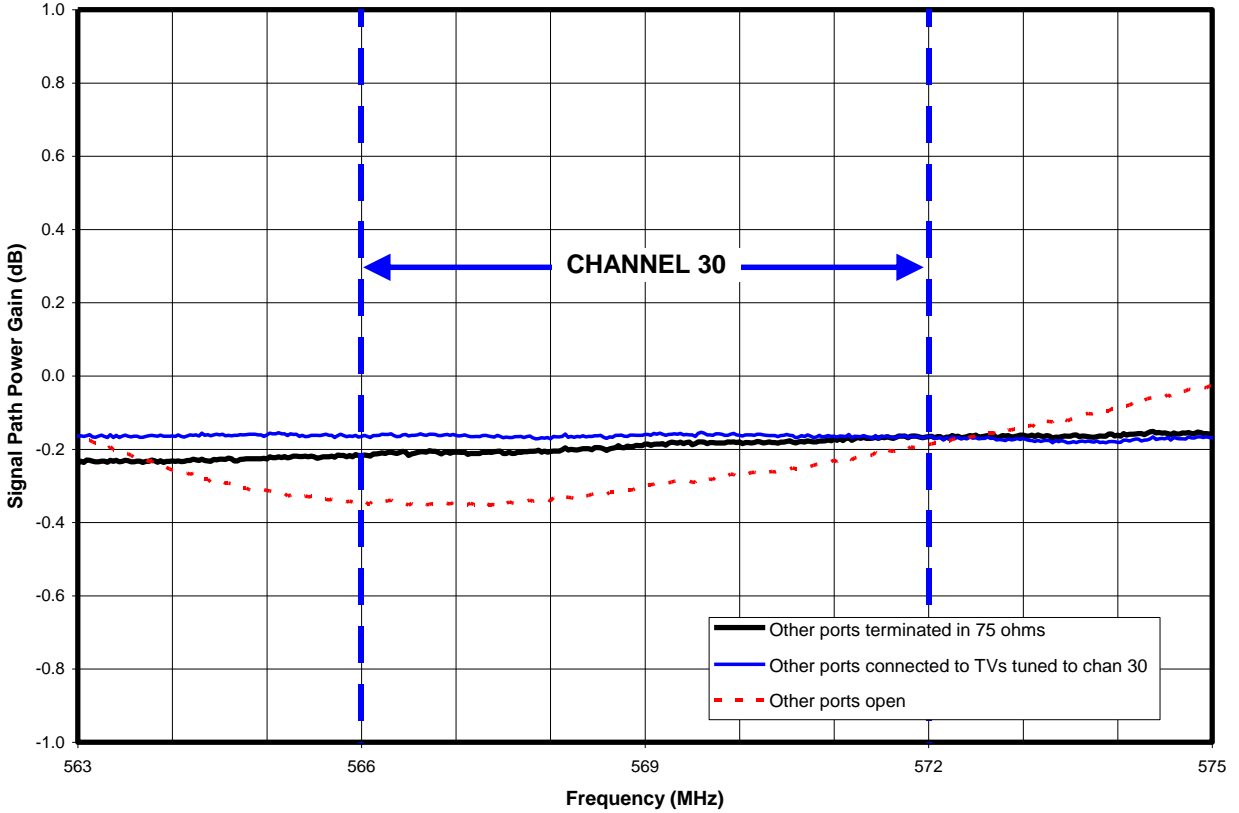

Figure A-4. Effect of Load Impedance Mismatch

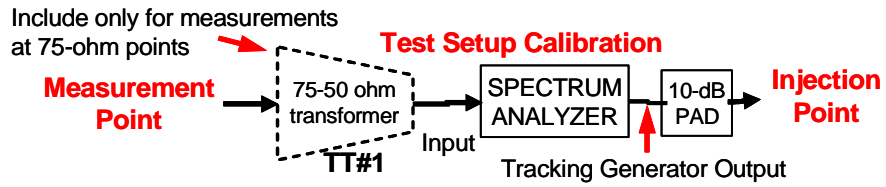

Figure A-5. Calibration Connection for Test Setup for Required CNR and RF Capture Tests

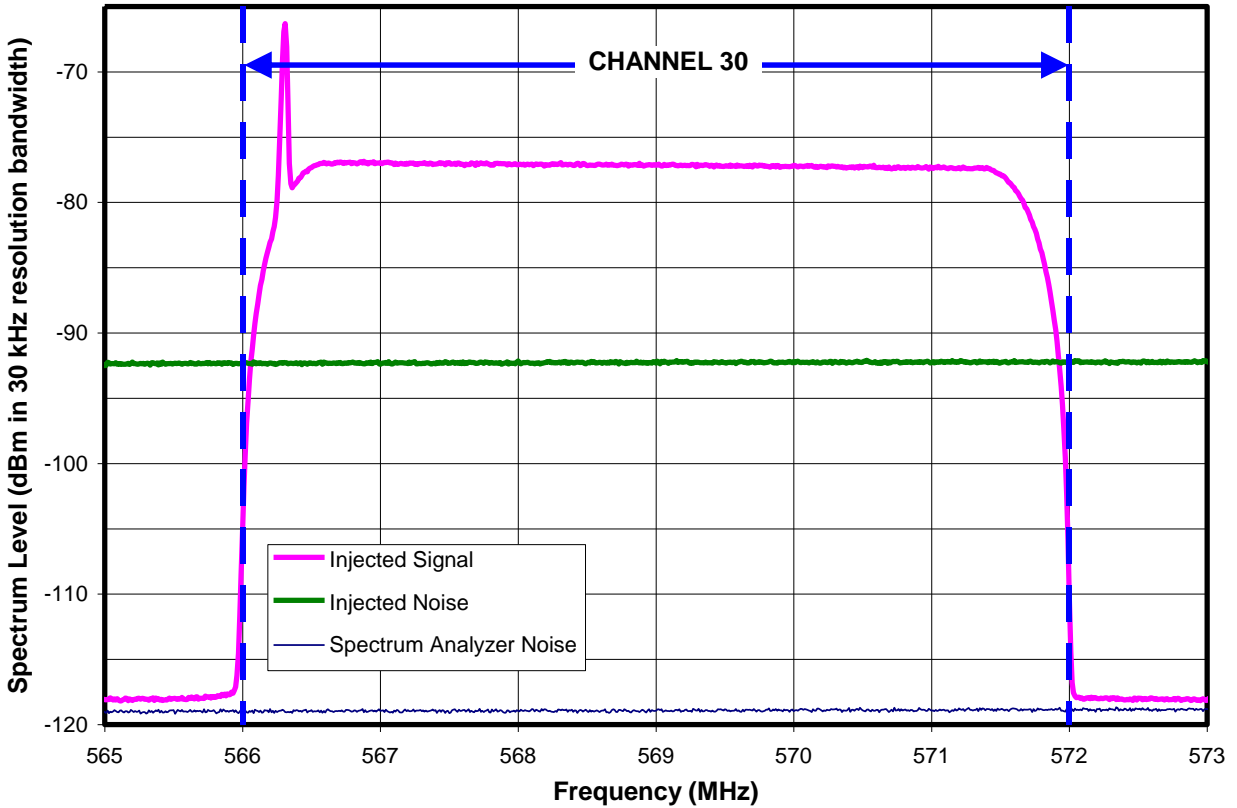

Figure A-6. Spectra of Injected Signal and Noise at 15-dB CNR

APPENDIX B

SUMMARY OF RF FIELD CAPTURES

Table B-1 lists the 50 ATSC-recommended captures, some of their characteristics, and the number of consumer DTV receivers (of 28) that successfully demodulated each capture in tests for this report.

The three captures having no video content (e.g., grey or black screens) were not tested, except with an instrumented receiver which is not included in the tabulated results. In counting observed video errors, errors coinciding with the locations of known symbol drops, as reported by the ATSC, were not counted. Note that four of the captures on which no tested receiver achieved demodulation free of visual errors were identified by the ATSC as having possible non-linearities caused by high-level adjacent channels overdriving the recording system.

Notes on Table B-1 (next page):

All captures have durations of 23 or 25 seconds

* Site: HR = high rise apartment; SF = single family home; TH = townhouse

Antenna: ID = indoors at 6-ft height; OD = outdoors at 30-ft height

**Issues: DS = 48 dropped symbols at specified location; NL = recording may contain nonlinearities due to strong adjacent channel

Table B-1. RF Field Captures

| File # | Original data capture filename | Chan | Site / Antenna* | Distance from Tx (Miles) | Known Issues** | # of Receivers w/No Errors | # of Receivers w/≤2 Errors |
|--------|--------------------------------|------|-----------------|--------------------------|----------------|----------------------------|----------------------------|
| 01 | NYC_200_44_10272000_DBT1 | 44 | HR / ID | 2.0 | | 10 | 10 |
| 02 | NYC_200_44_10272000_LOOP1 | 44 | HR / ID | 2.0 | | 0 | 0 |
| 03 | NYC_200_44_10272000_MEGA1 | 44 | HR / ID | 2.0 | | 10 | 10 |
| 04 | NYC_200_44_10272000_RAB1 | 44 | HR / ID | 2.0 | | 10 | 10 |
| 05 | NYC_200_44_10272000_SSEN1 | 44 | HR / ID | 2.0 | | 10 | 10 |
| 06 | NYC_200_44_10272000_SSEN2 | 44 | HR / ID | 2.0 | | 10 | 10 |
| 07 | NYC_200_44_10272000_SSEN3 | 44 | HR / ID | 2.0 | | 0 | 0 |
| 08 | NYC_200_44_10272000_YAGI1 | 44 | HR / ID | 2.0 | | 13 | 13 |
| 09 | NYC_200_56_10272000_BWT1 | 56 | HR / ID | 2.0 | | 2 | 10 |
| 10 | NYC_200_56_10272000_DBT2 | 56 | HR / ID | 2.0 | | 10 | 10 |
| 11 | NYC_200_56_10272000_DSEN1 | 56 | HR / ID | 2.0 | | 10 | 10 |
| 12 | NYC_200_56_10272000_DSEN2 | 56 | HR / ID | 2.0 | | 1 | 14 |
| 13 | NYC_200_56_10272000_LOOP1 | 56 | HR / ID | 2.0 | | 10 | 10 |
| 14 | NYC_200_56_10272000_MEGA1 | 56 | HR / ID | 2.0 | | 11 | 11 |
| 15 | NYC_200_56_10272000_RAB1 | 56 | HR / ID | 2.0 | | 10 | 10 |
| 16 | NYC_200_56_10272000_SSEN1 | 56 | HR / ID | 2.0 | | 0 | 10 |
| 17 | NYC_200_56_10272000_YAG1 | 56 | HR / ID | 2.0 | | 10 | 10 |
| 18 | WAS_06_34_06092000_REF | 34 | SF / OD | 10.8 | | 8 | 10 |
| 19 | WAS_23_34_06072000_OPT | 34 | SF / ID | 16.7 | | 28 | 28 |
| 20 | WAS_23_48_06072000_OPT | 48 | SF / ID | 15.5 | | 0 | 8 |
| 21 | WAS_3_27_06022000_REF | 27 | SF / OD | 48.4 | | 9 | 13 |
| 22 | WAS_3_35_06022000_REF | 35 | SF / OD | 51.9 | No Video | NA | NA |
| 23 | WAS_311_34_06052000_OPT | 34 | HR / ID | 4.3 | NL | 0 | 0 |
| 24 | WAS_311_35_06052000_REF | 35 | HR / OD | 3.9 | No Video | NA | NA |
| 25 | WAS_311_36_06052000_REF | 36 | HR / OD | 4.7 | | 13 | 14 |
| 26 | WAS_311_39_06052000_OPT | 39 | HR / ID | 4.3 | | 0 | 0 |
| 27 | WAS_311_48_06052000_REF | 48 | HR / OD | 3.9 | | 2 | 11 |
| 28 | WAS_32_48_06012000_OPT | 48 | SF / ID | 17.8 | NL | 0 | 0 |
| 29 | WAS_34_27_06082000_OPT | 27 | TH / ID | 7.5 | | 7 | 27 |
| 30 | WAS_34_35_06082000_OPT | 35 | TH / ID | 9.6 | NL | 11 | 13 |
| 31 | WAS_34_48_06082000_OPT | 48 | TH / ID | 9.6 | | 7 | 11 |
| 32 | WAS_38_34_05312000_OPT | 34 | TH / ID | 14.3 | DS@15.0 sec | 26 | 26 |
| 33 | WAS_38_34_05312000_REF | 34 | TH / OD | 14.3 | DS@15.1 sec | 27 | 28 |
| 34 | WAS_38_36_05312000_OPT | 36 | TH / ID | 14.3 | DS@22.2 sec | 24 | 24 |
| 35 | WAS_47_48_06132000_OPT | 48 | SF / ID | 13.1 | DS@13.8 sec | 27 | 28 |
| 36 | WAS_49_34_06142000_OPT | 34 | SF / ID | 20.2 | Possible DS | 0 | 0 |
| 37 | WAS_49_39_06142000_OPT | 39 | SF / ID | 20.2 | DS@24.9 sec | 10 | 11 |
| 38 | WAS_51_35_05242000_REF | 35 | SF / OD | 20.3 | | 8 | 8 |
| 39 | WAS_63_34_06212000_OPT | 34 | SF / ID | 12.7 | | 0 | 9 |
| 40 | WAS_68_36_05232000_REF | 36 | SF / OD | 17.7 | NL | 0 | 8 |
| 41 | WAS_75_35_06162000_OPT | 35 | SF / ID | 10.0 | | 0 | 1 |
| 42 | WAS_75_36_06162000_OPT | 36 | SF / ID | 10.9 | NL | 0 | 0 |
| 43 | WAS_75_39_06162000_OPT | 39 | SF / ID | 10.5 | | 10 | 13 |
| 44 | WAS_80_35_06152000_OPT | 35 | TH / ID | 9.9 | No Video | NA | NA |
| 45 | WAS_81_36_06192000_OPT | 36 | SF / ID | 9.6 | | 12 | 27 |
| 46 | WAS_82_35_06202000_OPT | 35 | SF / ID | 8.3 | DS@17.2 sec | 27 | 28 |
| 47 | WAS_83_36_06222000_OPT | 36 | TH / ID | 3.5 | DS@14.9 sec | 2 | 5 |
| 48 | WAS_83_39_06222000_OPT | 39 | TH / ID | 3.0 | DS@12.2 sec | 28 | 28 |
| 49 | WAS_86_36_07122000_OPT | 36 | SF / ID | 33.3 | | 10 | 10 |
| 50 | WAS_86_48_07122000_REF | 48 | SF / OD | 34.4 | | 1 | 5 |

See notes on preceding page